

Owner's Manual

MAGNAVOX

SMART. VERY SMART.

ZC350MS8

DIGITAL VIDEO DISC RECORDER



THANK YOU FOR CHOOSING MAGNAVOX.

NEED HELP FAST?

READ YOUR QUICK GUIDE AND/OR OWNER'S MANUAL FIRST FOR QUICK TIPS THAT MAKE USING YOUR MAGNAVOX PRODUCT MORE ENJOYABLE.

IF YOU HAVE READ YOUR INSTRUCTIONS AND STILL NEED ASSISTANCE, YOU MAY ACCESS OUR ONLINE HELP AT [HTTP://WWW.FUNAI-CORP.COM](http://www.funai-corp.com) OR CALL **1-800-605-8610** WHILE WITH YOUR PRODUCT.

INSTRUCCIONES EN ESPAÑOL INCLUIDAS.



© 2007 Funai Electric Co., Ltd.

Introduction

Connections

Basic Setup

Recording

Playback

Editing

Function Setup

Others

Español

PRECAUTIONS

WARNING: TO REDUCE THE RISK OF FIRE OR ELECTRIC SHOCK, DO NOT EXPOSE THIS APPLIANCE TO RAIN OR MOISTURE.



CAUTION:
TO REDUCE THE RISK OF ELECTRIC SHOCK, DO NOT REMOVE COVER (OR BACK). NO USER SERVICEABLE PARTS INSIDE. REFER SERVICING TO QUALIFIED SERVICE PERSONNEL.

 The lightning flash with arrowhead symbol, within an equilateral triangle, is intended to alert the user to the presence of uninsulated "dangerous voltage" within the product's enclosure that may be of sufficient magnitude to constitute a risk of electric shock to persons.

 The exclamation point within an equilateral triangle is intended to alert the user to the presence of important operating and maintenance (servicing) instructions in the literature accompanying the appliance.

The caution marking is located on the rear of the cabinet.

Laser Safety

This unit employs a laser. Only a qualified service person should remove the cover or attempt to service this device, due to possible eye injury.

CAUTION: USE OF CONTROLS OR ADJUSTMENTS OR PERFORMANCE OF PROCEDURES OTHER THAN THOSE SPECIFIED HEREIN MAY RESULT IN HAZARDOUS RADIATION EXPOSURE.

CAUTION: VISIBLE AND INVISIBLE LASER RADIATION WHEN OPEN AND INTERLOCK DEFEATED. DO NOT STARE INTO BEAM.

LOCATION: INSIDE, NEAR THE DECK MECHANISM.

FCC WARNING- This equipment may generate or use radio frequency energy. Changes or modifications to this equipment may cause harmful interference unless the modifications are expressly approved in the manual. The user could lose the authority to operate this equipment if an unauthorized change or modification is made.

RADIO-TV INTERFERENCE

This equipment has been tested and found to comply with the limits for a Class B digital device, pursuant to Part 15 of the FCC Rules. These limits are designed to provide reasonable protection against harmful interference in a residential installation. This equipment generates, uses, and can radiate radio frequency energy and, if not installed and used in accordance with the instructions, may cause harmful interference to radio communications. However, there is no guarantee that interference will not occur in a particular installation. If this equipment does cause harmful interference to radio or television reception, which can be determined by turning the equipment off and on, the user is encouraged to try to correct the interference by one or more of the following measures:

- 1) Reorient or relocate the receiving antenna.
- 2) Increase the separation between the equipment and receiver.
- 3) Connect the equipment into an outlet on a circuit different from that to which the receiver is connected.
- 4) Consult the dealer or an experienced radio/TV technician for help.

This Class B digital apparatus complies with Canadian ICES-003.

Cet appareil numérique de la classe B est conforme à la norme NMB-003 du Canada.

CAUTION: TO PREVENT ELECTRIC SHOCK, MATCH WIDE BLADE OF PLUG TO WIDE SLOT, FULLY INSERT.

ATTENTION: POUR ÉVITER LES CHOCS ÉLECTRIQUES, INTRODUIRE LA LAME LA PLUS LARGE DE LA FICHE DANS LA BORNE CORRESPONDANTE DE LA PRISE ET POUSSER JUSQU'AU FOND.

A NOTE ABOUT RECYCLING

This product's packaging materials are recyclable and can be reused. Please dispose of any materials in accordance with your local recycling regulations.

Batteries should never be thrown away or incinerated but disposed of in accordance with your local regulations concerning chemical wastes.

Make your contribution to the environment!!!

- Used up batteries do not belong in the dust bin.
- You can dispose of them at a collection point for used up batteries or special waste. Contact your council for details.



For Customer Use:

Read carefully the information located at the back of this unit and enter below the Model No. and Serial No. Retain this information for future reference.

Model No. _____

Serial No. _____



PRECAUTIONS

Important Safeguards

1. Read Instructions - All the safety and operating instructions should be read before the appliance is operated.
2. Retain Instructions- The safety and operating instructions should be retained for future reference.
3. Heed Warnings - All warnings on the appliance and in the operating instructions should be adhered to.
4. Follow Instructions - All operating and use instructions should be followed.
5. Cleaning - Unplug this product from the wall outlet before cleaning. Do not use liquid cleaners or aerosol cleaners. Use a damp cloth for cleaning.
EXCEPTION: A product that is meant for uninterrupted service and, that for some specific reason, such as the possibility of the loss of an authorization code for a CATV converter, is not intended to be unplugged by the user for cleaning or any other purpose, may exclude the reference to unplugging the appliance in the cleaning description otherwise required in item 5.
6. Attachments - Do not use attachments not recommended by the product manufacturer as they may cause hazards.
7. Water and Moisture- Do not use this product near water, for example, near a bath tub, wash bowl, kitchen sink, or laundry tub, in a wet basement, or near a swimming pool, and the like.
8. Accessories - Do not place this product on an unstable cart, stand, tripod, bracket, or table. The product may fall, causing serious injury to a child or adult, and serious damage to the appliance. Use only with a cart, stand, tripod, bracket, or table recommended by the manufacturer, or sold with the product. Any mounting of the appliance should follow the manufacturer's instructions and should use a mounting accessory recommended by the manufacturer. An appliance and cart combination should be moved with care. Quick stops, excessive force, and uneven surfaces may cause the appliance and cart combination to overturn.
9. Ventilation - Slots and openings in the cabinet are provided for ventilation and to ensure reliable operation of the product and to protect it from overheating, and these openings must not be blocked or covered. The openings should never be blocked by placing the product on a bed, sofa, rug, or other similar surface. This product should not be placed in a built-in installation such as a bookcase or rack unless proper ventilation is provided or the manufacturer's instructions have been adhered to.
10. Power Sources - This product should be operated only from the type of power source indicated on the marking label. If you are not sure of the type of power supply to your home, consult your appliance dealer or local power company. For products intended to operate from battery power, or other sources, refer to the operating instructions.
11. Grounding or Polarization - This product is equipped with a polarized alternating-current line plug (a plug having one blade wider than the other). This plug will fit into the power outlet only one way. This is a safety feature. If you are unable to insert the plug fully into the outlet, try reversing the plug. If the plug should still fail to fit, contact your electrician to replace your obsolete outlet. Do not defeat the safety purpose of the polarized plug.
12. Power Cord Protection - Power supply cords should be routed so that they are not likely to be walked on or pinched by items placed upon or against them, paying particular attention to cords at plugs, convenience receptacles, and the point where they exit from the appliance.
13. Outdoor Antenna Grounding - If an outside antenna or cable system is connected to the product, be sure the antenna or cable system is grounded so as to provide some protection against voltage surges and built-up static charges. Article 810 of the National Electrical Code, ANSI/NFPA No. 70, provides

PORTABLE CART WARNING
(Symbol provided by RETAC)



SS125A

information with regard to proper grounding of the mast and supporting structure, grounding of the lead-in wire to an antenna discharge unit, size of grounding conductors, location of antenna-discharge unit, connection to grounding electrodes, and requirements for the grounding electrode. (Fig. A)

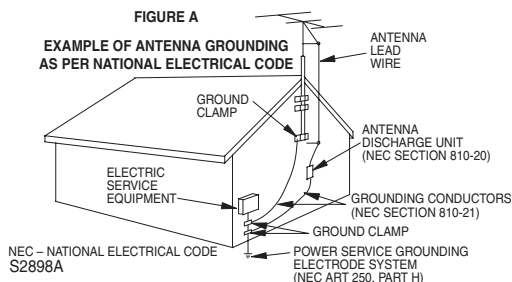

14. Lightning - For added protection for this product during a lightning storm, or when it is left unattended and unused for long periods of time, unplug it from the wall outlet and disconnect the antenna or cable system. This will prevent damage to the product due to lightning and power-line surges.
15. Power Lines - An outside antenna system should not be located in the vicinity of overhead power lines or other electric light or power circuits, or where it can fall into such power lines or circuits. When installing an outside antenna system, extreme care should be taken to keep from touching such power lines or circuits as contact with them might be fatal.
16. Overloading - Do not overload wall outlets and extension cords as this can result in a risk of fire or electric shock.
17. Object and Liquid Entry - Never push objects of any kind into this product through any openings as they may touch dangerous voltage points or short-out parts that could result in a fire or electric shock. Never spill liquid of any kind on the product.
18. Servicing - Do not attempt to service this product yourself as opening or removing covers may expose you to dangerous voltage or other hazards. Refer all servicing to qualified service personnel.
19. Damage Requiring Service - Unplug this product from the wall outlet and refer servicing to qualified service personnel under the following conditions:
 - a. When the power-supply cord or plug is damaged.
 - b. If liquid has been spilled, or objects have fallen into the product.
 - c. If the product has been exposed to rain or water.
 - d. If the product does not operate normally by following the operating instructions. Adjust only those controls that are covered by the operating instructions as an improper adjustment of other controls may result in damage and will often require extensive work by a qualified technician to restore the product to its normal operation.
 - e. If the product has been dropped or damaged in any way.
 - f. When the product exhibits a distinct change in performance this indicates a need for service.
20. Replacement Parts - When replacement parts are required, be sure the service technician has used replacement parts specified by the manufacturer or have the same characteristics as the original part. Unauthorized substitutions may result in fire, electric shock or other hazards.
21. Safety Check - Upon completion of any service or repairs to this product, ask the service technician to perform safety checks to determine that the product is in proper operating condition.
22. Heat - This product should be situated away from heat sources such as radiators, heat registers, stoves, or other products (including amplifiers) that produce heat.

Introduction

Connections

Basic Setup

Recording

Playback

Editing

Function Setup

Others

Español



PRECAUTIONS

Installation Location

For safety and optimum performance of this unit:

- Install the unit in a horizontal and stable position. Do not place anything directly on top of the unit. Do not place the unit directly on top of the TV.
- Shield it from direct sunlight and keep it away from devices of intense heat. Avoid dusty or humid places. Avoid places with insufficient ventilation for proper heat dissipation. Do not block the ventilation holes on the sides of the unit. Avoid locations subject to strong vibration or strong magnetic fields.

Avoid the Hazards of Electrical Shock and Fire

- Do not handle the power cord with wet hands.
- Do not pull on the power cord when disconnecting it from AC outlet. Grasp it by the plug.
- If, by accident, water is spilled on this unit, unplug the power cord immediately and take the unit to our Authorized Service Center for servicing.

Moisture Condensation Warning

Moisture condensation may occur inside the unit when it is moved from a cold place to a warm place or after heating a cold room or under conditions of high humidity. Do not use this unit at least for 2 hours until its inside gets dry.

About Copyright

Unauthorized copying, broadcasting, public performance and lending of discs are prohibited.

This product incorporates copyright protection technology that is protected by U.S. patents and other intellectual property rights. Use of this copyright protection technology must be authorized by Macrovision, and is intended for home and other limited viewing uses only unless otherwise authorized by Macrovision. Reverse engineering or disassembly is prohibited.

Notice for Progressive Scan Output

Consumers should note that not all high definition television sets are fully compatible with this product and may cause artifacts to be displayed in the picture. In case of picture problems with 525 progressive scan output, it is recommended that the user switch the connection to the 'standard definition' output. If there are questions regarding your TV set compatibility with this 525p DVD player, please contact our customer service center.

Supplied Accessories

remote control (NB553UD) with batteries (AAx2)

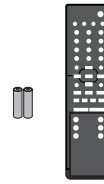

RF coaxial cable (WPZ0901TM002)

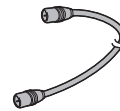

RCA audio/video cables (WPZ0102TM018/WPZ0102LTE01)

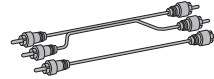

owner's manual (1VMN23563)



quick guide (1VMN23564)



blank media DVD+R (16x) disc (KDDZZZMB006)





PRECAUTIONS

Maintenance

Servicing

- Please refer to relevant topics on "TROUBLESHOOTING" on pages 86-90 before returning the product.
- If this unit becomes inoperative, do not try to correct the problem by yourself. There are no user-serviceable parts inside. Turn off, unplug the power plug and please call our help line mentioned on the front page to locate an Authorized Service Center.

Cleaning the cabinet

- Use a soft cloth slightly moistened with a mild detergent solution. Do not use a solution containing alcohol, spirits, ammonia or abrasive.

Cleaning discs

- When a disc becomes dirty, clean it with a cleaning cloth. Wipe the disc from the center to out. Do not wipe in a circular motion.
- Do not use solvents such as benzine, thinner, commercially available cleaners, detergent, abrasive cleaning agents or antistatic spray intended for analog records.

Cleaning the disc lens

- If this unit still does not perform properly although you refer to the relevant sections and to "TROUBLESHOOTING" in this owner's manual, the laser optical pickup unit may be dirty. Consult your dealer or an Authorized Service Center for inspection and cleaning of the laser optical pickup unit.

Disc handling

- Handle the discs so that fingerprints and dust do not adhere to the surfaces of the discs.
- Always store the disc in its protective case when it is not used.

IR signal check

If the remote control does not work properly, you can test if the remote control sends out the infrared signal with AM radio or a digital camera (including built-in camera of cellular phone). It will help to define the cause of malfunction.

• With an AM radio:

Tune an AM radio to a station with no broadcasting. Press a button on remote control toward the radio. Sound will be fluttering when you press any key and the radio receives the signal. This means the remote control is working.



• With a digital camera (including built-in camera of cellular phone):

Direct a digital camera to remote control, press and hold a button on remote control. If infrared light appears through digital camera, the remote control is working.



Manufactured under license from Dolby Laboratories. "Dolby" and the double-D symbol are trademarks of Dolby Laboratories.

Dolby Digital Recording

"Dolby® Digital Recording enables consumers to record high-quality video with stereo sound on recordable DVD discs. The technology, when utilized instead of PCM recording, also saves recordable disc space, allowing for higher video resolution or extended recording time on each DVD. DVDs created using Dolby Digital Recording will play back on all DVD-video players."

Note: This is true when the players are compatible with actual recordable DVD discs.

© 2007 Funai Electric Co., Ltd.

All rights reserved. No part of this manual may be reproduced, copied, transmitted, disseminated, transcribed, downloaded or stored in any storage medium, in any form or for any purpose without the express prior written consent of Funai. Furthermore, any unauthorized commercial distribution of this manual or any revision hereto is strictly prohibited.

Information in this document is subject to change without notice. Funai reserves the right to change the content herein without the obligation to notify any person or organization of such changes.

FUNAI with the  design is a registered trademark of Funai Electric Co., Ltd and may not be used in any way without the express written consent of Funai. All other trademarks used herein remain the exclusive property of their respective owners. Nothing contained in this manual should be construed as granting, by implication or otherwise, any license or right to use any of the trademarks displayed herein. Misuse of any trademarks or any other content in this manual is strictly prohibited. Funai shall aggressively enforce its intellectual property rights to the fullest extent of the law.



CONTENTS

Introduction

PRECAUTIONS	2
FEATURES	7
Symbols Used in this Owner's Manual	7
FUNCTIONAL OVERVIEW	8
Front Panel	8
Rear Panel	9
Remote Control	10

Connections

ANTENNA CABLE CONNECTION	12
RF MODULATOR CONNECTION	13
CONNECTION TO A CABLE / SATELLITE BOX	14
CONNECTION TO A TV	15
CONNECTION TO AN AUDIO SYSTEM	16

Basic Setup

GUIDE TO ON-SCREEN DISPLAYS AND MENUS	17
On-Screen Display / Menu	17
Main Menu	18
INITIAL SETTING	19
CHANNEL SETTING	20
Auto Channel Scan	20
Adding / Deleting Channels	21
SETTING THE CLOCK	23
Auto Clock Setting	23
Manual Clock Setting	24
Daylight Saving Time	24
TUNER SETTINGS	25
Switching Analog Mode / Digital Mode	25
Channel Selection	25
Selecting TV Audio	26
DTV Closed Caption	28
Closed Caption Style	29

Recording

INFORMATION ON DVD RECORDING	31
BEFORE RECORDING	32
Make Recording Compatible	32
Setting for Auto Chapter	32
BASIC RECORDING &	
ONE-TOUCH TIMER RECORDING	33
TIMER RECORDING	35
Hints for Timer Recording	38
OVERWRITING UNNECESSARY TITLE	39
Overwriting from the Beginning of the Title	39
Overwriting in the Middle of the Title	39
Hints for Overwriting	40
SETTINGS FOR AN EXTERNAL DEVICE	41
Connection to an External Device	41
Recording from an External Device	42
SETTING A DISC TO PROTECT	43
PLAYING THE DISCS IN OTHER DVD PLAYERS	44
Finalizing a Disc	44
Auto Finalizing	45

Playback

INFORMATION ON PLAYBACK	46
BASIC PLAYBACK	48
Direct Playback	48
Playback from the Title List	49

Playing Back an Audio CD and a CD-RW/-R with MP3 Files	51
Using the Title / Disc Menu	52
Pause	52

SPECIAL PLAYBACK	53
Resume Playback	53
Fast Forward / Fast Reverse Playback	53
Skipping TV Commercials During Playback	53
Rapid Playback	54
Step by Step Playback	54
Slow Forward / Slow Reverse Playback	54
Zoom	55
Marker Setting	55

SEARCH	56
Title / Chapter Search	56
Track Search	56
Time Search	57

REPEAT / RANDOM / PROGRAM PLAYBACK	58
Repeat Playback	58
Random Playback	58
Program Playback	59

SELECTING THE FORMAT OF AUDIO AND VIDEO ..	60
Switching Subtitles	60
Switching Audio Soundtrack	60
Switching Virtual Surround System	61
Switching Camera Angles	61
Reducing Block Noise	61

Editing

INFORMATION ON DISC EDITING	62
Guide to a Title List	62
Editing Discs	62

EDITING DISCS	63
Deleting Titles	63
Putting Names on Titles	64
Setting Chapter Marks	65
Clearing Chapter Marks	66
Hiding Chapters	68
Setting Pictures for Thumbnails	69
Dividing a Title	70
Putting Name on Disc	71
Setting or Releasing Disc Protect	72
Erasing Disc	73
Making Edits Compatible	74

Function Setup

LIST OF SETTINGS	75
SETUPS	77
Playback	77
Display	81
Video	83
Reset All	85

Others

TROUBLESHOOTING	86
Frequently Asked Questions	90
LANGUAGE CODE	91
GLOSSARY	92
SPECIFICATIONS	93

Español

ESPAÑOL	94
----------------------	-----------

LIMITED WARRANTY	Back cover
-------------------------------	-------------------

FEATURES

This unit not only plays back DVD and CD but also offers features for you to record on DVD and edit them after that. The following features are offered with this unit.

Recording

This unit is compatible with DVD+RW/DVD-RW, which is rewritable repeatedly and DVD+R/DVD-R, which is available for recording once. You can choose either one for your convenience. Even if you choose DVD-RW/-R, these discs will automatically be recorded in the DVD+VR mode.

Up to 12 program recording:

You can program the unit to record up to 12 programs within a one-month period. Daily or weekly program recordings are also available.

One-touch timer recording (OTR):

You can easily set a recording time as you prefer. Every time [RECORD] or [REC ●] is pressed during recording, the recording time will be increased by 30 minutes up to 6 hours. The recording automatically stops when the recording time you set is reached or the disc is full.

Automatic chapter mark setting:

Chapter marks will be put on recordings as you set before attempting to record.

Automatic title list making:

The unit makes a title list with the index automatically.

Left channel stereo recording:

This unit can record the sound of the left channel monaural input as left and right channels automatically (the input from the E2 only).

Playback

Theater surround sound in your home:

When connecting the unit to an amplifier or a decoder which is compatible with Dolby Digital, you can experience the theater surround sound from discs with surround sound system.

Quick search for what you want to watch:

You can easily find the part you want to watch using the search function. Search for a desired point on a disc by title, chapter or time.

Virtual surround system:

You can enjoy stereophonic space through your existing 2 channel stereo system.

Playing back MP3 files:

You can enjoy MP3 files which are recorded on CD-RW/-R.

Editing

Deleting titles:

You can delete titles which you do not need anymore.

Putting names on titles:

You can put your favorite names on titles.

Setting / clearing chapter marks:

You can set / clear chapter marks on titles.

Hiding chapters:

To keep others from playing back some chapters without permission, you can hide chapters.

Setting pictures for thumbnails:

You can change pictures for thumbnails.

Dividing titles:

You can divide a title into 2 or more.

Putting name on disc:

You can put your favorite disc name.

Compatibility

Available for playing back discs on a regular DVD player:

Recorded discs can be played back on regular DVD players, including computer DVD drives compatible with DVD-video playback. Although DVD+R are playable on other units without finalization in most cases, it is recommended to finalize in order to stabilize the performance. For DVD-RW/-R, you need to finalize the recorded discs to play back on other DVD players.

Others

Progressive scan system

Unlike conventional interlace scanning, the progressive scan system provides less flickering and images in higher resolution than that of traditional television signals.

Symbols Used in this Owner's Manual

To specify for what disc type each function is, we put the following symbols at the beginning of each item to operate.

- * DVD-RW/-R recorded in VR mode or non compatible recording format are not playable.
- * DVD-RW recorded in the mode other than +VR is not recordable on this unit unless you erase all contents in the disc (refer to page 73).
- * DVD-R recorded in the mode other than +VR is not recordable on this unit.

Symbol Description

For Recording, Playing Back, and Editing

 Description refers to DVD+RW

 Description refers to DVD+R

 Description refers to DVD-RW

 Description refers to DVD-R

For Playback only

 Description refers to DVD-video

 Description refers to audio CD

 Description refers to video CD with PBC function

 Description refers to video CD without PBC function

 Description refers to CD-RW/-R with MP3 files

If you do not find any of the symbols listed above under the function heading, the operation is applicable to all media.

FUNCTIONAL OVERVIEW

Front Panel

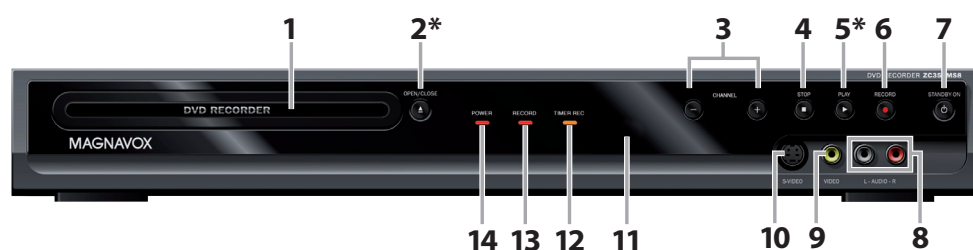

(*) The unit can also be turned on by pressing these buttons.

1. Disc tray

Place a disc when opening the disc tray.

2. OPEN/CLOSE ▲ button*

Press to open or close the disc tray.

3. CHANNEL + / - buttons

Press to change the channel up and down.

4. STOP ■ button

Press to stop playback or recording.

5. PLAY ► button*

Press to start or resume playback.

6. RECORD ● button

Press once to start a recording. Press repeatedly to start one-touch timer recording.

7. STANDBY-ON ○ button

Press to turn the unit on and off.

If timer programmings have been set, press to set the unit in timer-standby mode.

8. AUDIO input jacks (E2)

Use to connect external device with a RCA audio cable.

9. VIDEO input jack (E2)

Use to connect external device with a RCA video cable.

10. S-VIDEO input jack (E2)

Use to connect the S-video output of external device with an S-video cable.

11. Infrared sensor window

Receive signals from your remote control so that you can control the unit from a distance.

12. TIMER REC indicator

Lights up when timer programming is set.

Lights up during one-touch timer recording.

Flashes when all timer programmings have been finished, or when a program cannot be performed by some reason.

13. RECORD indicator

Lights up when recording function works.

14. POWER indicator

Lights up when power is on.

FUNCTIONAL OVERVIEW

Rear Panel

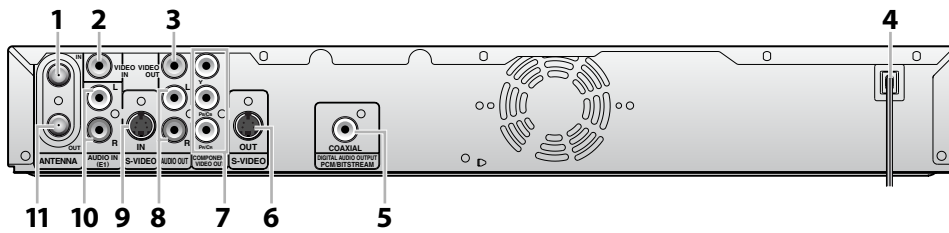

1. ANTENNA IN jack

Use to connect an antenna.

2. VIDEO IN jack (E1)

Use to connect external device with a RCA video cable.

3. VIDEO OUT jack

Use to connect a TV monitor, AV receiver or other device with a RCA video cable.

4. AC Power Cord

Connect to a standard AC outlet to supply power to this unit.

5. COAXIAL DIGITAL AUDIO OUTPUT jack

Use to connect an AV receiver, Dolby Digital decoder or other device with a coaxial digital input jack with a digital coaxial cable.

6. S-VIDEO OUT jack

Use to connect the S-video input of a TV monitor, AV receiver or other device with an S-video cable.

7. COMPONENT VIDEO OUTPUT jacks

Use to connect a TV monitor with component video inputs with a component video cable.

8. AUDIO OUT jacks

Use to connect a TV monitor, AV receiver or other device with a RCA audio cable.

9. S-VIDEO IN jack (E1)

Use to connect the S-video output of external device with an S-video cable.

10. AUDIO IN jacks (E1)

Use to connect external device with a RCA audio cable.

11. ANTENNA OUT jack

Use to connect an RF coaxial cable to pass the signal from the ANTENNA IN to your TV.

Note

- Do not touch the inner pins of the jacks on the rear panel. Electrostatic discharge may cause permanent damage to the unit.
- This unit does not have the RF modulator.

FUNCTIONAL OVERVIEW

Remote Control

Installing the Batteries in the Remote Control

Install the batteries (AAAx2) matching the polarity indicated inside battery compartment of the remote control.

1 Open the cover.

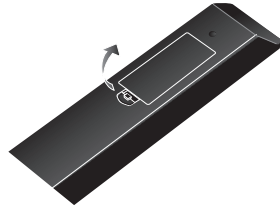

2 Insert batteries.



Make sure to match + and - on the batteries to the marks indicated in the battery compartment.

3 Close the cover.



Note

Incorrect use of batteries can result in hazards such as leakage and bursting. Please observe the following:

- Do not mix new and old batteries together.
- Do not use different kinds of batteries together. Although they may look similar, different batteries may have different voltages.
- Make sure that the + and - ends of each battery match the indications in the battery compartment.
- Remove batteries from battery compartment that is not going to be used for a month or more.
- When disposing of used batteries, please comply with governmental regulations or environmental public instruction's rules that apply in your country or area.
- Do not recharge, short-circuit, heat, burn or disassemble batteries.

Using a Remote Control

Keep in mind the following when using the remote control:

- Make sure that there are no obstacles between the remote control and the infrared sensor window on the unit.
- Remote operation may become unreliable if strong sunlight or fluorescent light is shining on the infrared sensor window of the unit.
- Remote control for different devices can interfere with each other. Avoid using remote control for other device located close to the unit.
- Replace the batteries when you notice a fall off in the operating range of the remote control.
- The maximum operable ranges from the unit are as follows.
 - **Line of sight:** approx. 23 feet (7m)
 - **Either side of the center:** approx. 16 feet (5m) within 30°
 - **Above:** approx. 16 feet (5m) within 15°
 - **Below:** approx. 10 feet (3m) within 30°

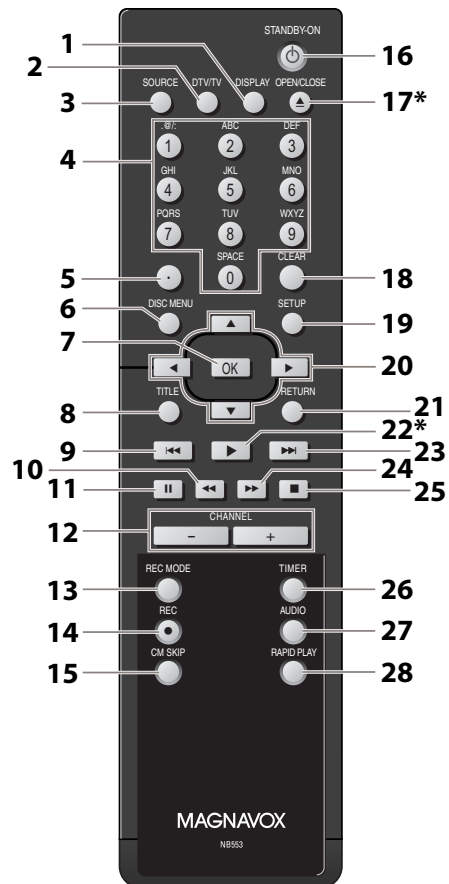

FUNCTIONAL OVERVIEW

(*) The unit can also be turned on by pressing these buttons.

1. DISPLAY button

Press to display the display menu on or off.

2. DTV/TV button

Press to switch between digital TV mode (DTV) and analog TV mode.

3. SOURCE button

Press to select the appropriate input.

4. Number/Character buttons

- Press to select channel numbers.
- Press to select a title/chapter/track/file on display.
- Press to enter values for the settings in the Setup menu.
- Press to enter title names.

5. Confirm (•) button

Analog mode:

Press to confirm the channel selection made by [the Number buttons].

Digital mode:

Press to confirm the major / minor channel selection made by [the Number buttons].

6. DISC MENU button

Press to display the disc menu.

7. OK button

Press to confirm or select menu items.

8. TITLE button

Press to display the title list.

9. PREV ◀◀ button

- During playback, press to return to the beginning of the current chapter, track or file.
- When playback is paused, press to play back reverse step by step.

10. REW ◀◀ button

- During playback, press to fast reverse.
- When playback is paused, press to play back slow reverse.

11. PAUSE || button

Press to pause playback or recording.

12. CHANNEL + / - buttons

Press to change the channel up and down.

13. REC MODE button

Press to switch the recording mode.

14. REC ● button

- Press once to start a recording.
- Press repeatedly to start the one-touch timer recording.

15. CM SKIP button

During playback, press to skip 30 seconds.

16. STANDBY-ON ⏻ button

Press to turn the unit on and off. If timer program-mings have been set, press to set the unit in timer-standby mode.

17. OPEN/CLOSE ▲ button*

Press to open or close the disc tray.

18. CLEAR button

Press to clear the password once entered or to cancel the programming for CD or to clear the selected marker number, etc.

19. SETUP button

- Press to display the main menu.
- During DVD playback, press and hold for more than 3 seconds to switch the progressive scanning mode to the interlace mode.

20. Cursor ▲ / ▼ / ◀ / ▶ buttons

Press to select items or settings.

21. RETURN button

Press to return to the previously displayed menu screen.

22. PLAY ▶ button*

Press to start or resume playback.

23. NEXT ▶▶ button

- During playback, press to skip to the next chapter, track or file.
- When playback is paused, press to play back forward step by step.

24. FFW ▶▶ button

- During playback, press to play back fast forward.
- When playback is paused, press to play back slow forward.

25. STOP ■ button

- Press to stop playback or recording.
- Press to exit from the title list.

26. TIMER button

Press to display the timer programming list.

27. AUDIO button

Analog mode:

Press to display the audio menu during playback.

Digital mode:

- Press to switch the audio language in stop mode.
- Press to display the audio menu during playback.

28. RAPID PLAY button

During playback, press to playback in a slightly faster/slower mode with keeping the audio quality.

Introduction

Connections

Basic Setup

Recording

Playback

Editing

Function Setup

Others

Español

ANTENNA CABLE CONNECTION

This section describes how to connect your unit to an antenna, cable box, etc.

1 Disconnect the power cord of your TV from the AC outlet.

2 Disconnect RF coaxial cable from antenna input jack of your TV.

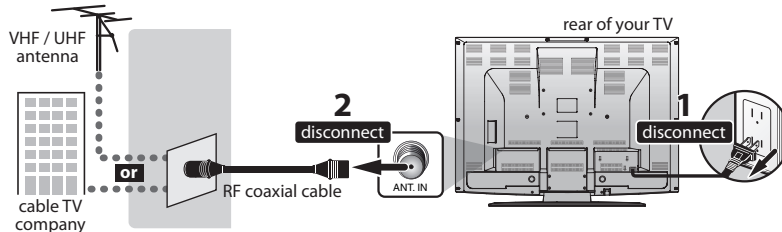

3 Connect cables to the unit.
Make the basic connection as illustrated below.

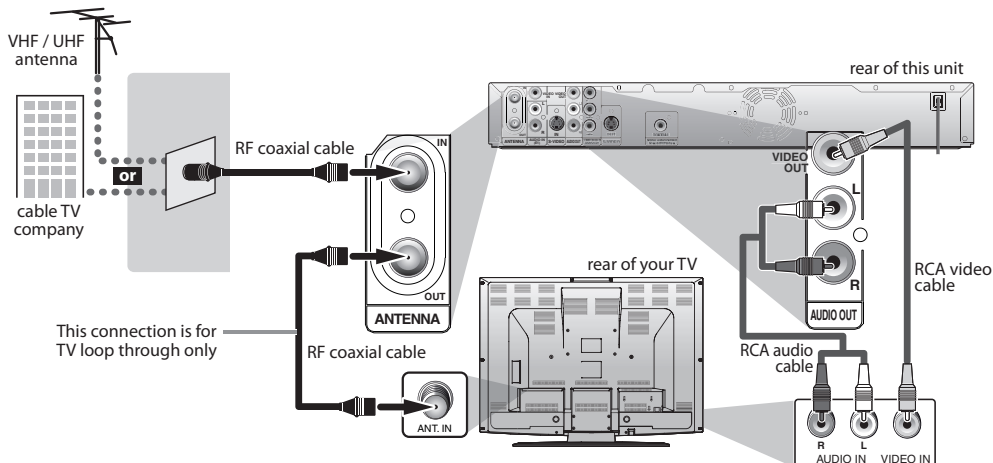

4 Plug in the power cord of this unit and your TV to the AC outlet.

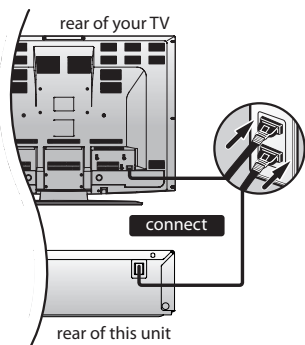

Supplied cables used in this connection are as follows:

- RF coaxial cable x 1
 - RCA audio cable (L/R) x 1
 - RCA video cable x 1
- Please purchase the rest of the necessary cables at your local store.

*Once connections are completed, turn on the TV and begin initial setting.
Channel scanning is necessary for the unit to memorize all available channels in your area.
(Refer to "INITIAL SETTING" on page 19.)

Note

- For your safety and to avoid damage to the device, please unplug the RF coaxial cable from the ANTENNA IN jack before moving the unit.
- If you use an antenna to receive analog TV, it should also work for DTV reception. Outdoor or attic antennas will be more effective than set-top versions.
- Antenna out is for tuner pass through only. DVD playback through the RF is not possible.

RF MODULATOR CONNECTION

If your TV has antenna in jack only, it is still possible to connect this unit to your TV by using a commercially available stereo audio/video RF modulator. In this case, follow the instructions below.

- 1) Disconnect the power cords of the devices from the AC outlet.
- 2) Make the connection as illustrated below.
- 3) **Set your RF modulator's channel 3/4 switch to either 3 or 4**, whichever the TV channel is least used in your area. If your RF modulator has a modulator/antenna switch, set it according to the manual supplied with the RF modulator.
- 4) Plug in the power cords of the devices to the AC outlet.
- 5) **Turn on your TV and choose the same channel as you set the RF modulator's channel 3/4 switch to.** For more details, follow the manual supplied with the RF modulator.

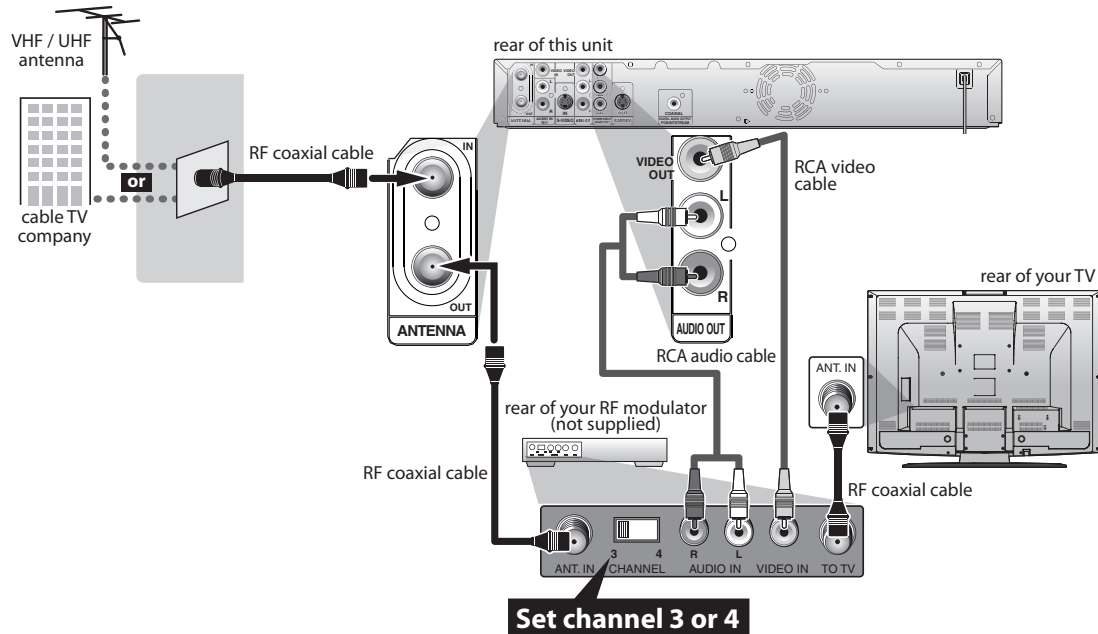

Supplied cables used in this connection are as follows:

- RF coaxial cable x 1
- RCA audio cable (L/R) x 1
- RCA video cable x 1

Please purchase the rest of the necessary cables at your local store.

Note

- RF modulator is not supplied with this unit. You need to purchase it at your local store.
- The quality of picture may become poor if this unit is connected to an RF modulator.

CONNECTION TO A CABLE / SATELLITE BOX

- 1) Disconnect the power cords of the devices from the AC outlet.
- 2) Make the connection as illustrated below.
- 3) Plug in the power cords of the devices to the AC outlet.

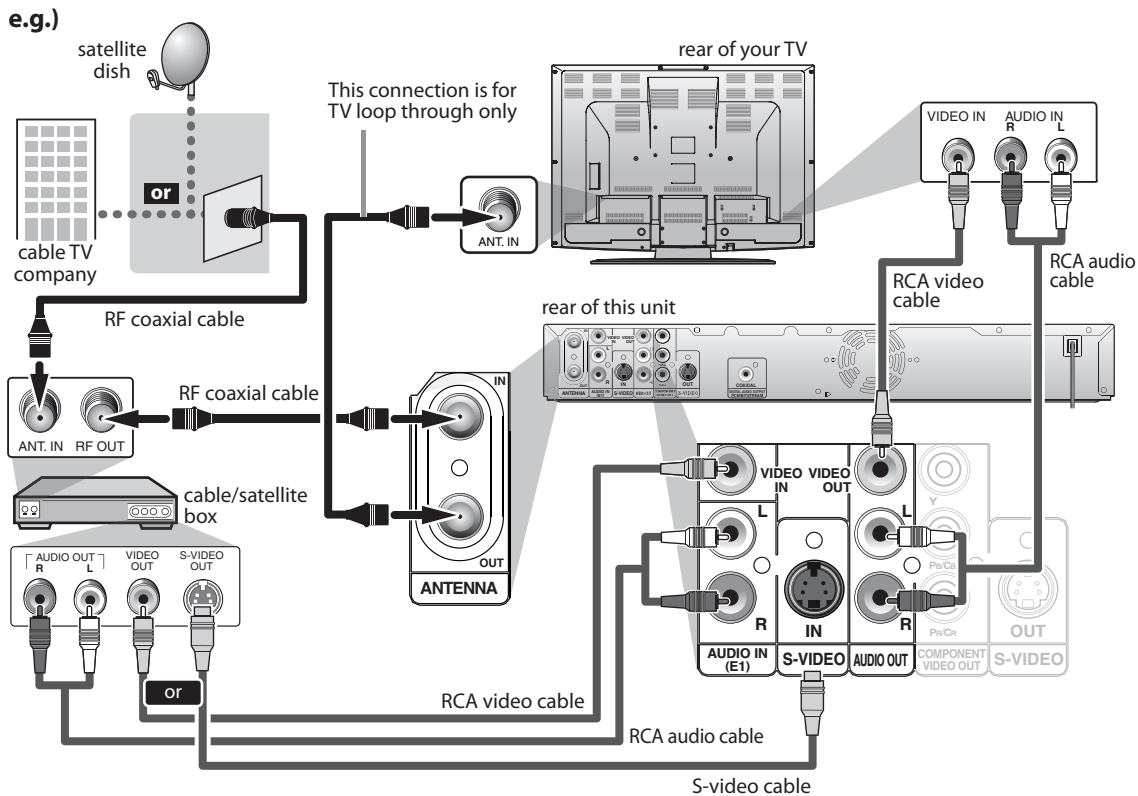

Supplied cables used in this connection are as follows:

- RF coaxial cable x 1
- RCA audio cable (L/R) x 1
- RCA video cable x 1

Please purchase the rest of the necessary cables at your local store.

Note

- Required cables and connecting methods differ depending on the cable/satellite box. For more information, please contact your cable/satellite provider.

With this setup:

- You can record any unscrambled channel by selecting the channel on the cable/satellite box. Be sure that the cable/satellite box is turned on.
- **You cannot record one channel while watching another channel.**

Note to CATV system installer

- This reminder is provided to call the cable TV system installer's attention to Article 820-40 of the National Electrical Code, which provides guidelines for proper grounding - in particular, specifying that the cable ground shall be connected to the grounding system of the building, as close to the point of cable entry as possible.

CONNECTION TO A TV

Make one of the following connections, depending on the capabilities of your existing device.

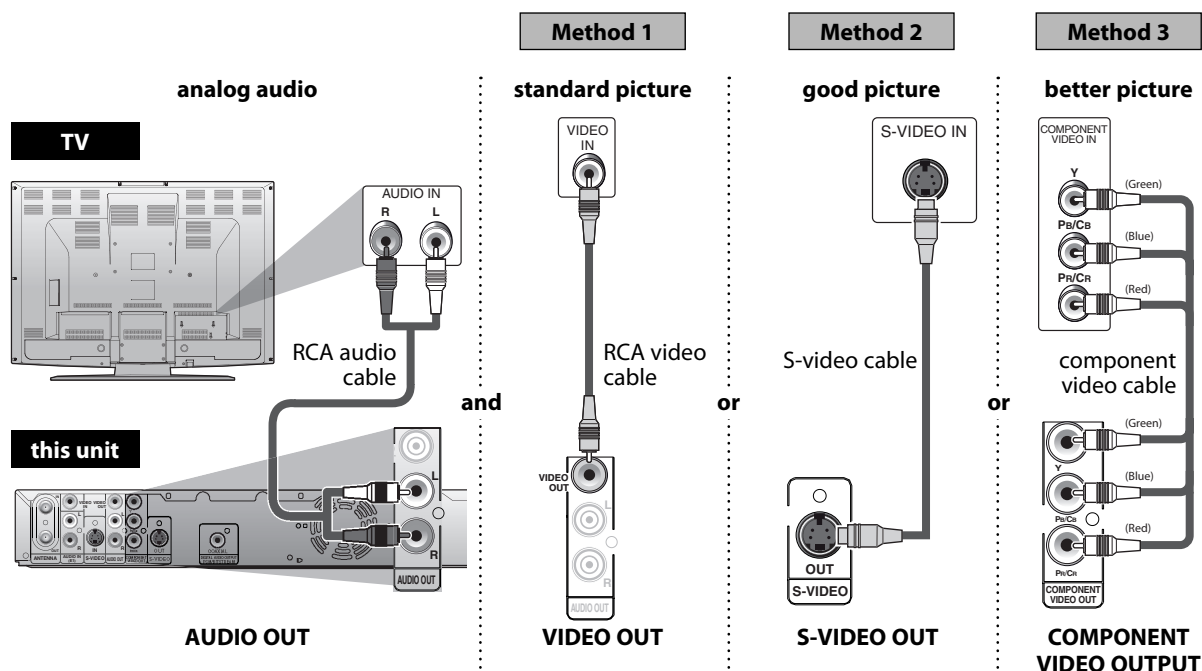

Supplied cables used in this connection are as follows:

- RCA audio cable (L/R) x 1
- RCA video cable x 1

Please purchase the rest of the necessary cables at your local store.

After you have completed the connections

- Switch the input selector on your TV to an appropriate external input channel. Press a button on the TV's original remote control that selects an external input channel until the DVD recorder's opening picture appears. Check your TV owner's manual for details.

Note

- Connect this unit directly to the TV. If the RCA audio/video cables are connected to a VCR, pictures may be distorted due to the copy protection system.
- When "Progressive Scan" is set to "ON", no video signal will be output from the VIDEO OUT or S-VIDEO OUT jack.

To set progressive scan mode, refer to page 84

- This unit is compatible with the progressive scan system. The feature provides you with the higher quality images than the traditional output system does. To utilize this feature, you must set "Progressive Scan" to "ON".

CONNECTION TO AN AUDIO SYSTEM

- When you change the connections, all devices should be turned off.
- Refer to the manual accompanying external devices for more information.

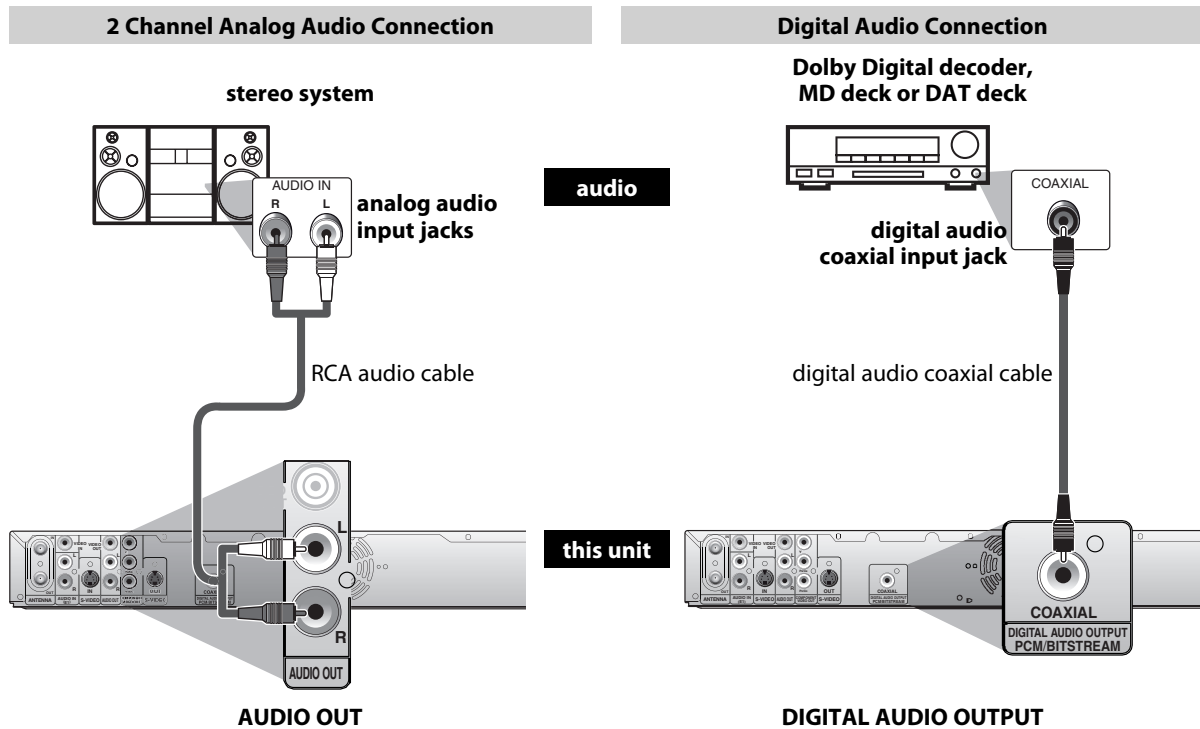

Supplied cables used in this connection are as follows:

- RCA audio cable (L/R) x 1
- Please purchase the rest of the necessary cables at your local store.

Connection	Setting	Setup >General Setting >Playback >Disc Audio >Dolby Digital
If output is Dolby Digital encoded audio, connect to a Dolby Digital decoder.		Stream
Connecting to an MD deck or DAT deck.		PCM
If not connected to any external devices.		PCM

* To complete these settings, refer to page 79.

Note

- The audio source on a disc in a Dolby Digital multi channel surround format cannot be recorded as digital sound by an MD or DAT deck.
- By connecting this unit to a Dolby Digital decoder, you can enjoy high-quality Dolby Digital multi channel surround sound as heard in the movie theaters.
- Playing back a DVD using incorrect settings may generate noise distortion and may also damage the speakers.

GUIDE TO ON-SCREEN DISPLAYS AND MENUS

This unit uses the following on-screen displays and menus to guide you to the easy operations. The on-screen displays give you the information on the loaded disc, the disc/file in playback, etc. The menus allow you to change the various kinds of settings for playing back, recording, or editing to suite your preference.

On-Screen Display / Menu

The on-screen display changes in the following order as you press [DISPLAY].

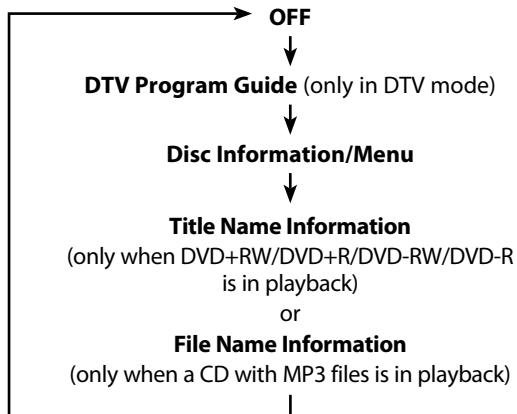

DTV Program Guide

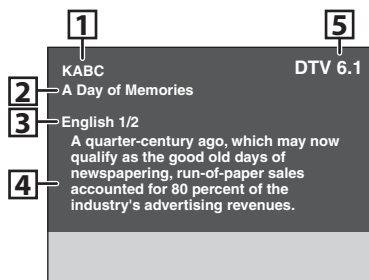

1. Broadcast station
2. Program title (max. 2 lines displayed)
3. Audio language ("Other" is displayed when the audio language cannot be acquired, or the acquired languages are other than English, Spanish or French.)
4. Program guide (max. 6 lines displayed)
5. Channel number

Note

- When the program guide is displayed in more than 7 lines, use [▲ / ▼] to scroll.
- "No description provided" is displayed when the program guide is not provided.

Disc Information / Menu

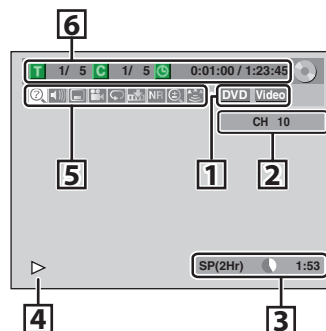

* This is an example screen only for explanation.

1. Indicates a disc type and format mode.
2. Indicates a channel number or selected external input position.
3. Indicates a recording mode and possible recording time left.
4. Indicates an operation status.
5. Each icon means:

: Search	: Marker
: Audio	: Noise Reduction
: Subtitle	: Zoom
: Angle	: Surround
: Repeat	
6. Indicates the current title number/total number of titles, the current chapter number/total number of chapters, and time lapse of the current title playback/total duration of the title.

Note

- This is an example screen only for explanation. Displayed items are depending on the disc you inserted.

Title/File Name Information

Title Name Information

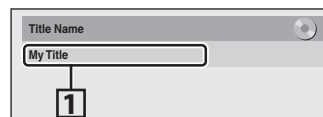

File Name Information

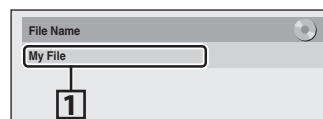

1. Displays title/file name.

GUIDE TO ON-SCREEN DISPLAYS AND MENUS

Main Menu

Press **[SETUP]** to display the main menu. Then use **[▲ / ▼]** to select a menu and press **[OK]** to display the menu. These menus provide entries to all main functions of the unit.

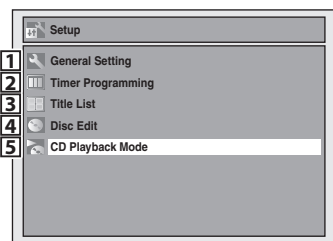

1. General Setting:

To go to general setting menu.

2. Timer Programming:

To program a timer recording.

3. Title List:

To call up the title list.

4. Disc Edit:

To set up the DVD disc setting.

5. CD Playback Mode:

To set up the CD playback setting.

- "CD Playback Mode" is available only when an audio CD, a video CD, a CD-RW/-R with MP3 files is inserted into the unit.

General Setting Menu

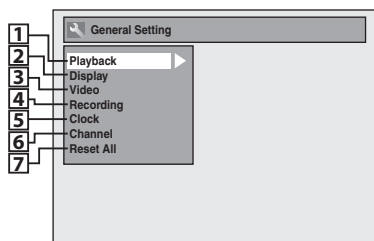

1. Playback:

To set up the unit to play back discs as you prefer.

2. Display:

To set up the OSD screen as you prefer.

3. Video:

To set up the video setting.

4. Recording:

To set up the unit to record to discs as you prefer.

5. Clock:

To set up the clock of the unit as you need.

6. Channel:

To adjust the channel setting of the unit as you prefer.

7. Reset All:

To reset the setting to the factory default.

Disc Edit / CD Playback Mode

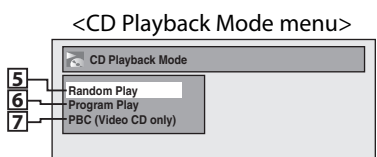
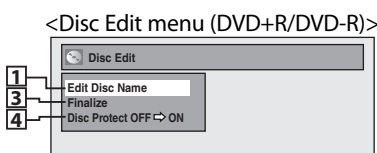
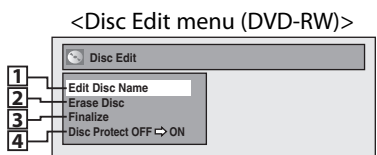
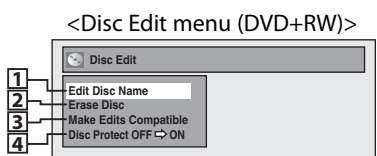

1. Edit Disc Name:

Allows you to rename the disc.

2. Erase Disc: (DVD+RW/DVD-RW only)

Allows you to erase all contents in the disc and format it.

3. Make Edits Compatible: (DVD+RW only)

Allows you to memorize the editing status on the disc if you have added or deleted chapters, or made chapters hidden on this unit, and to effect it when playing back on the other unit.

Finalize: (DVD+R/DVD-RW/-R only)

Allows you to finalize a disc containing recorded titles.

4. Disc Protect :

Allows you to protect a disc from accidental editing or recording.

5. Random Play:

Allows you to activate the random playback feature.

6. Program Play: (audio CD/video CD only)

Allows you to activate the program playback feature.



7. PBC (Video CD only):

Allows you to select images or information on the menu screen by activating PBC (playback control) function.



INITIAL SETTING

You need to follow these steps when you turn on this unit for the first time.



- 1** Press [STANDBY-ON ].
Turn the TV on. Select the input to which the unit is connected.
- 2** Use [ / ] to select your desired language, then press [OK] to set language.



- 3** Use [ / ] to select the type of broadcasting signal, then press [OK].

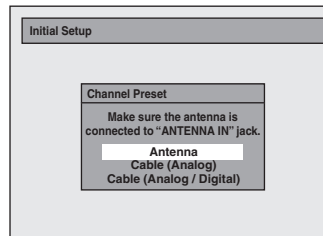

The unit will start getting channels available in your area.

Antenna:

(When using antenna)

The channels broadcasted in analog TV and digital TV are automatically scanned and memorized. Only the receivable channels in the area will be memorized.

Cable (Analog):

(When using basic cable)

The channels broadcasted in analog CATV are automatically scanned and memorized.

Cable (Analog / Digital):

(When using basic cable)

The channels broadcasted in analog CATV and digital CATV are automatically scanned and memorized.



To cancel the auto channel preset during scanning:

Press [RETURN] or [SETUP] to cancel.

- 4** Press [OK] to activate "Clock Setting".

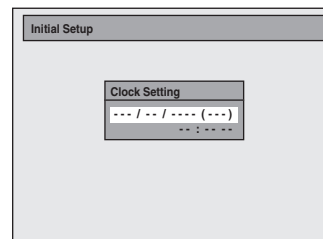

- 5** Proceed to step 5 in "Manual Clock Setting" on page 24.

- If a PBS (public broadcasting station) is available in your area, press [RETURN] or [SETUP] to exit, then follow "Auto Clock Setting" on page 23.

CHANNEL SETTING

If you have changed antenna connection, we recommend that you program available channels in your area with the following procedures.

Auto Channel Scan



1 Press [SETUP] and use [▲ / ▼] to select "General Setting", then press [OK].

"General Setting" menu will appear.

2 Use [▲ / ▼] to select "Channel", then press [OK].

"Channel" menu will appear.

3 Use [▲ / ▼] to select "Auto Channel Preset", then press [OK].

4 Use [▲ / ▼] to select the type of broadcasting signal, then press [OK].

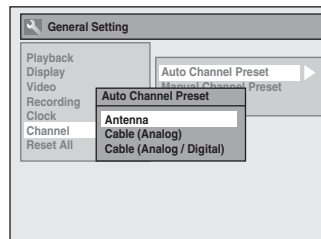

The unit will start getting channels available in your area.

- When aerial antenna is connected, select "Antenna".
- When connected to CATV, select "Cable (Analog)" or "Cable (Analog/Digital)".

To cancel the auto channel preset during scanning:

Press [RETURN] or [SETUP] to cancel.

5 When scanning is over, press [SETUP] to exit.

To cycle through only the memorized channels, use [CHANNEL + / -].

To select a channel directly (including the ones not memorized), use [the Number buttons].

Note

- If the auto channel preset is canceled during presetting, some channels not yet preset may not be received.

CHANNEL SETTING

Adding / Deleting Channels

You may want to add or delete TV channels if your channel lineup changes or if you no longer watch some channels.

Adding channel is only available for the analog TV channels.

Make sure

- You perform "Auto Channel Scan" before adding or deleting the channels.



1 Press [DTV/TV] to select the mode (DTV or TV) to/from which you want to add/delete channels.

2 Press [SETUP] and use [▲ / ▼] to select "General Setting", then press [OK].

"General Setting" menu will appear.

3 Use [▲ / ▼] to select "Channel", then press [OK].

"Channel" menu will appear.

4 Use [▲ / ▼] to select "Manual Channel Preset", then press [OK].

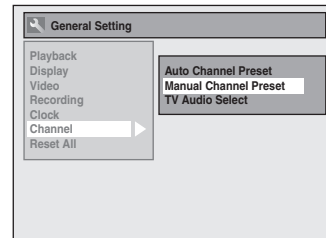

- If you are adding or deleting analog TV/CATV channels, go to **ANALOG** to continue.
- If you are deleting digital TV/CATV channels, go to **DIGITAL** to continue.

Introduction

Connections

Basic Setup

Recording

Playback

Editing

Function Setup

Others

Español

Instructions continue on the next page.

CHANNEL SETTING

ANALOG

5 Select the channel number to add or delete.

- Use [CHANNEL + / -] to cycle through only the memorized channels.
- Use [◀ / ▶] to cycle through all the channels including the ones not memorized.
- Use [the Number buttons] to select a channel directly.
- When a memorized channel is selected, "Add" is checked and highlighted as a default.
- When an unmemorized channel is selected "Delete" is checked and highlighted as a default.

6 Use [▲ / ▼] to select "Add" or "Delete", then press [OK].

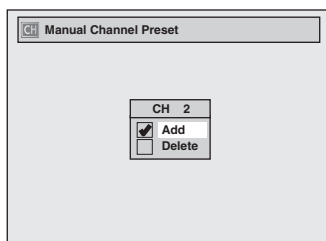

Your setting will be activated and it will automatically switch to the next channel so that you can continue adding or deleting channels.

7 Press [SETUP] to exit.

DIGITAL

5 Select the channel number to delete.

- Only the major channel is displayed in "Manual Channel Preset" menu. (The channel number displayed in the parenthesis is a virtual channel number)
- Use [CHANNEL + / -] to cycle through only the memorized channels.
- You cannot use [◀ / ▶] for the digital TV channel selection.
- Use [the Number buttons] to select a channel directly.
- When a memorized channel is selected, "Add" is checked and highlighted as a default.
- When an unmemorized channel is selected "Delete" is checked and highlighted as a default.

6 Use [▲ / ▼] to select "Delete", then press [OK]. Then select the next channel to delete.

- If the setting is complete, press [RETURN] to activate "Manual Channel Preset".

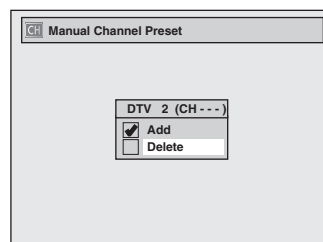

Your setting will be activated.

WARNING:

- For the digital TV channels, you cannot recover the deleted channels once they are deleted unless you perform the auto channel preset again.

7 Press [SETUP] to exit.

SETTING THE CLOCK

Set the clock before you try the timer programming. If a PBS (public broadcasting station) is available in your area, follow "Auto Clock Setting" below. If not, follow "Manual Clock Setting" on page 24.

Auto Clock Setting

This unit can set the time and date automatically by referring to a PBS station.

Make sure

- The antenna/cable TV connections are correct.
- Channels are set. (Refer to page 23.)
- If this unit is connected to a cable/satellite box, select the local PBS station on them to set the clock automatically.



Note

- The clock may set itself automatically after you connect the antenna/cable signal and plug in the power cord.
- Only the analog PBS channel signal is effective for auto clock setting.
- The unit receives the clock data at 12:00 a.m. / p.m. from the PBS channel when the power is off.

1 Press [SETUP] and use [▲ / ▼] to select "General Setting", then press [OK].

"General Setting" menu will appear.

2 Use [▲ / ▼] to select "Clock", then press [OK].

"Clock" menu will appear.

3 Use [▲ / ▼] to select "Auto Clock Setting", then press [OK].

4 Use [▲ / ▼] to select "Auto", then press [OK].

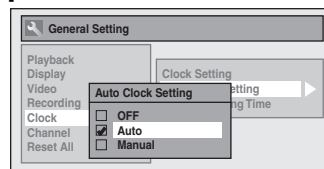

5 Press [SETUP] to exit.

6 Press [STANDBY-ON] to turn off the unit.

This unit will search for the time only when the power is off. Leave it off for several minutes to give this unit time to set the clock.

If the unit chooses an incorrect PBS channel, set the PBS channel manually by following the steps below.

1 Select "Manual" at step 4, then press [OK].

2 Use [the Number buttons] or [▲ / ▼] to enter your PBS channel number, then press [OK].

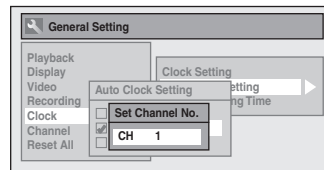

3 Press [SETUP] and turn off the unit.

SETTING THE CLOCK

Manual Clock Setting

1 Press [SETUP] and use [▲ / ▼] to select "General Setting", then press [OK].

"General Setting" menu will appear.

2 Use [▲ / ▼] to select "Clock", then press [OK].

"Clock" menu will appear.

3 Use [▲ / ▼] to select "Clock Setting", then press [OK].

4 Use [▲ / ▼] to select calendar or time, then press [OK].

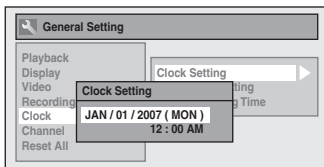

5 Use [◀ / ▶] to select an item to set, and use [▲ / ▼] to select the contents to suit your preference, then press [OK].

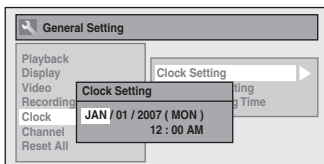

Your setting will be activated.

The clock start counting when you press [OK].

6 Press [SETUP] to exit.

Note

- Your clock setting will be lost if either there is a power failure or this unit has been unplugged for more than 30 seconds when you set the clock manually.
- For setting the day, year, hour, and minute, [the Number buttons] can also be used.
- You can set the built-in calendar from the year 2007 up to 2056.

Daylight Saving Time

When "Daylight Saving Time" is "ON", the unit clock will automatically adjust the time in order to fit the daylight saving time.

"ON (MAR - NOV)" has been selected as the default.

1 Press [SETUP] and use [▲ / ▼] to select "General Setting", then press [OK].

"General Setting" menu will appear.

2 Use [▲ / ▼] to select "Clock", then press [OK].

"Clock" menu will appear.

3 Use [▲ / ▼] to select "Daylight Saving Time", then press [OK].

4 Use [▲ / ▼] to select "ON (MAR - NOV)", "ON (APR - OCT)" or "OFF", then press [OK].

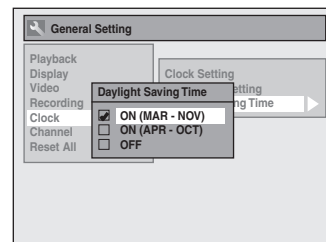

ON (MAR - NOV):

Move forward one hour on the second Sunday in March and move back one hour on the first Sunday in November.

ON (APR - OCT):

Move forward one hour on the first Sunday in April and move back one hour on the last Sunday in October.

5 Press [SETUP] to exit.

TUNER SETTINGS

Switching Analog Mode / Digital Mode

You can easily switch the analog TV (NTSC) and digital TV (ATSC) with the remote control and enjoy viewing the HDTV (high definition TV) programs as well as the SDTV (standard definition TV) programs.

Press **[DTV/TV]** on the remote control.

- The analog mode and digital mode switch alternately.

Note

- When you switch the analog mode to the digital mode, it may take about 10 seconds until the digital channel selection is completed. The following screen is displayed while switching the mode.



Channel Selection

Select channels by using **[CHANNEL + / -]** or **[the Number buttons]** found on remote control.

[CHANNEL + / -]

Use **[CHANNEL + / -]** to change the channel.

[the Number buttons]

Press the channel number with **[the Number buttons]** to select a channel you want to watch.

<Analog TV Channels>

Enter the channel number with **[the Number buttons]** to select a channel you want to watch.

For 1-digit number

e.g.) 2 ch: **[0] + [2], [2] + [•]** or **[2] + leave it for 2 seconds.**

For 2-digit number

e.g.) 12ch: **[1] + [2]**

<Digital TV Channels>

Enter the major and minor channel number with **[the Number buttons]** to select a channel you want to watch.

For 1-digit number

e.g.) 2-2 ch:
major channel **[0] + [2]** or **[2] + [•]**
minor channel **[0] + [2], [2] + [•]** or **[2] + leave it for 2 seconds.**

For 2-digit number

e.g.) 35-16ch:
major channel **[3] + [5]**
minor channel **[1] + [6]**

- If you enter 1 digit for major channel and leave it for 2 seconds, the number will be taken as the major channel and lowest minor channel of the major channel will be displayed.
- If there is no minor channel input, lowest minor channel of the major channel will be displayed.

Note

- It may take up to 5 to 7 seconds to switch the digital TV channels.
- In digital TV broadcasting, 2 or more channels, called minor channels, are simultaneously broadcast on one main channel, called major channel.

About digital TV broadcasting:

With its high definition broadcast, digital broadcasting far surpasses analog broadcasting in both its picture and sound quality.

What is the minor channel?

By using high compression technology, digital broadcasting offers a service that enables multiple signals to send simultaneously.

Therefore, you can select more than one program per major channel since digital broadcasting technology distinguishes between multiple channels broadcast by a signal network.

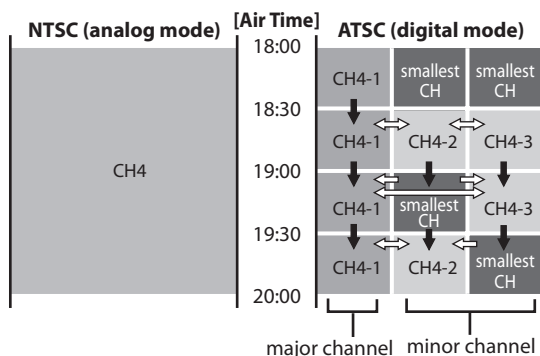

- ➡ : change automatically
- ⇔ : change manually by using **[CHANNEL +/-]**

TUNER SETTINGS

This section describes how to switch the TV audio. When you record a TV program, only the audio selected here will be recorded.

Selecting TV Audio

Digital TV



1 Press [AUDIO] to cycle through available audio languages.

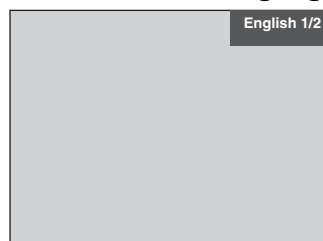

- When you press **[AUDIO]**, selected language will be displayed on the TV screen.
- Every time you press **[AUDIO]**, the language will be switched.
e.g.) English 1/3 → Spanish 2/3 → Other 3/3
- Available languages differ depending on the broadcast.
- The language information display will automatically disappear.
- When you record digital TV broadcasting, the audio language you have selected will be recorded.

Note

- The timer recording for digital TV cannot record any audio language other than English.
- Pressing **[AUDIO]** does not control external device audio.
- When there is only one audio channel on the broadcast, pressing **[AUDIO]** does not display anything.

TUNER SETTINGS

Selecting TV Audio (cont'd)

Analog TV



1 Press [SETUP] and use [▲ / ▼] to select "General Setting", then press [OK].
"General Setting" menu will appear.

2 Use [▲ / ▼] to select "Channel", then press [OK].
"Channel" menu will appear.

3 Use [▲ / ▼] to select "TV Audio Select", then press [OK].

4 Use [▲ / ▼] to select "Stereo" or "SAP", then press [OK].

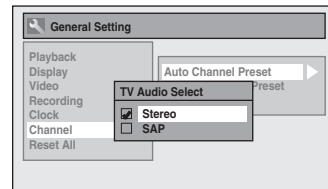

Stereo:

Outputs main-audio.

SAP (secondary audio program):

Outputs sub-audio.

5 Press [SETUP] to exit.

Note on recording analog TV audio

• When you record an analog TV program available in second audio or stereo, you have to select either "Stereo" or "SAP" in "General Setting" menu beforehand. Refer to the following table to check an appropriate setting.

Selected audio	Broadcast audio	Disc recording	Audio output
Stereo	STEREO+SAP	STEREO	STEREO
	STEREO	STEREO	STEREO
	MONO+SAP	MONO	MONO
	MONO	MONO	MONO
SAP	STEREO+SAP	SAP	SAP
	STEREO	STEREO	STEREO
	MONO+SAP	SAP	SAP
	MONO	MONO	MONO

TUNER SETTINGS

DTV Closed Caption

Digital TV

Digital TV has its own closed captions called DTV CC. Use this menu to change the settings for DTV CC.



1 Press [SETUP] and use [▲ / ▼] to select "General Setting", then press [OK].
"General Setting" menu will appear.

2 Use [▲ / ▼] to select "Display", then press [OK].

3 Use [▲ / ▼] to select "CC Style", then press [OK].

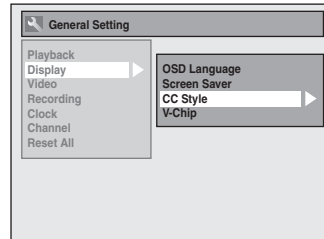

4 Use [▲ / ▼] to select "DTV CC", then press [OK].

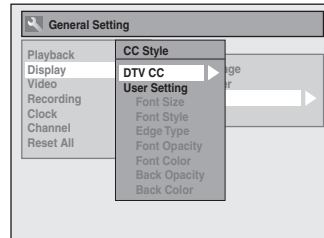

5 Use [▲ / ▼] to the desired DTV closed caption, then press [OK].

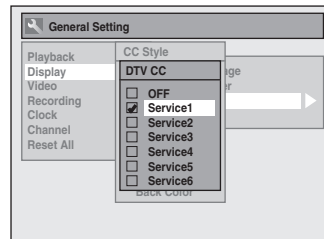

OFF:
Select if you do not want DTV CC. This is the default.

Service 1 to Service 6:
Select one of these before changing any other item in the closed caption menu. Choose "Service 1" under normal circumstances.

6 Press [SETUP] to exit.

Note

- Even if you set "DTV CC" to anything other than "OFF", its effect will temporarily be canceled while recording.

TUNER SETTINGS

Closed Caption Style

Digital TV

Digital TV can also change the style of its closed caption such as font, color or size, etc.



1 Press [SETUP] and use [▲ / ▼] to select "General Setting", then press [OK].

"General Setting" menu will appear.

2 Use [▲ / ▼] to select "Display", then press [OK].

3 Use [▲ / ▼] to select "CC Style", then press [OK].

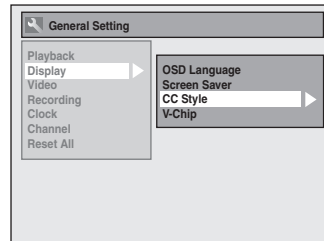

4 Use [▲ / ▼] to select "User Setting", then press [OK].

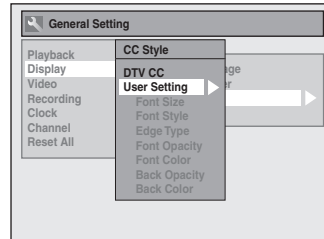

5 Use [▲ / ▼] to select "ON", then press [OK].

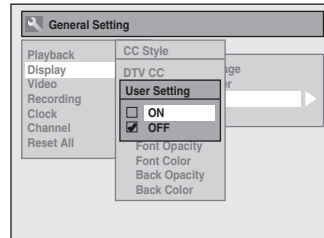

Instructions continue on the next page.

TUNER SETTINGS

6 Use [▲ / ▼] to select the item and switch the setting for each item you want to set, then press [OK].

- When "User Setting" is set to "ON", you can set the following items. CC style set by "User Setting" will be displayed.
- The setting description for each item is shown below.

Font size of the displayed caption can be switched as below.

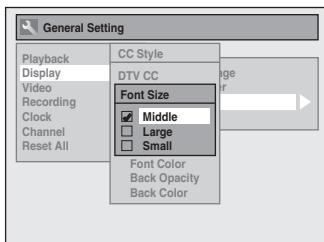

Font style of the displayed caption can be switched as below.

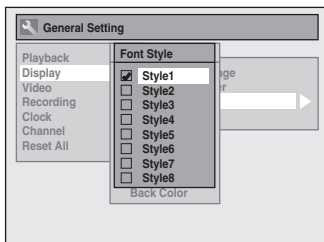

<Edge Type>

Edge type of the displayed caption can be switched as below.

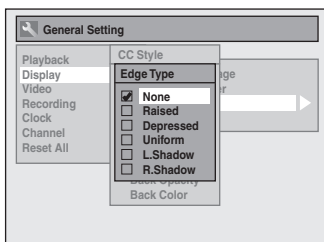

Font opacity of the displayed caption can be switched as below.

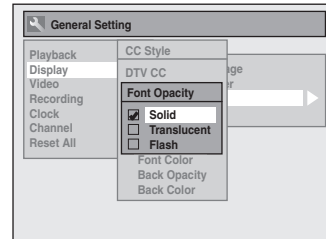

Font color of the displayed caption can be switched as below.

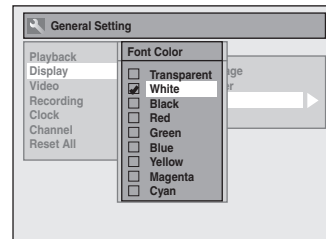

<Back Opacity>

Background opacity of the displayed caption can be switched as below.

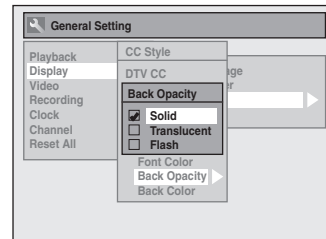

<Back Color>

Background color of the displayed caption can be switched as below.

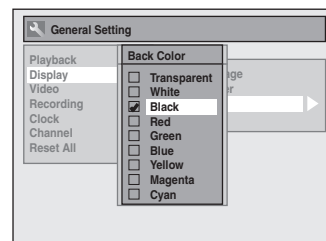







7 Press [SETUP] to exit.

INFORMATION ON DVD RECORDING

Before you make a recording, read the following information.

Recordable Discs

This unit can record to DVD+RW, DVD+R, DVD-RW and DVD-R.
 DVD+R/DVD-R can only be recorded to once. DVD+RW/DVD-RW can be recorded to and erased many times.
DVD-RW/-R will be recorded in the DVD+VR mode automatically in this unit.

Logo	Attributes
 DVD+RW	8cm/12cm, single-sided, single layer disc Approx. max. recording time (SLP mode): 360 minutes (4.7GB) (for 12cm) 108 minutes (1.4GB) (for 8cm)
 DVD+R	
 DVD-RW	
 DVD-R	
 DVD-RW	
 DVD-R	

• Following discs are recommended for good recording quality and are proven to be compatible with this unit. However, depending on the media condition the unit may not read the disc properly.

Verbatim	DVD+R 8x/16x,	DVD+RW 4x,
	DVD-R 8x,	DVD-RW 2x
JVC	DVD-RW 4x	
Maxell	DVD+R 4x/8x/16x,	DVD-R 8x/16x
SONY	DVD+R 4x/8x/16x,	DVD+RW 4x
TDK	DVD+R 4x/8x/16x	

Performance of any other discs are not guaranteed.

• **You can play back DVD+RW on most DVD players without finalizing. However, if you have added or deleted chapters, or made chapters hidden, you must perform "Make Edits Compatible" before being able to see those effects on other units. (Refer to page 74 for more details.) To play back discs other than DVD+RW on other DVD players, you will need to finalize.**

Unrecordable Discs

- DVD-RW recorded in the mode other than +VR is not recordable on this unit unless you erase all contents in the disc (refer to page 73).
- DVD-R recorded in the mode other than +VR is not recordable on this unit.

Recording Mode

You can select a recording mode among 6 options, and the recording time will depend on the recording mode you select as follows.

Disc size	Recording mode	Recording time	Video/sound quality
8cm Disc	HQ (1Hr)	18 min	☆☆☆☆☆☆ (good)
	SP (2Hr)	36 min	☆☆☆☆☆
	SPP (2.5Hr)	45 min	☆☆☆☆
	LP (3Hr)	54 min	☆☆☆
	EP (4Hr)	72 min	☆☆
	SLP (6Hr)	108 min	☆ (poor)
12cm Disc	HQ (1Hr)	60 min	☆☆☆☆☆☆ (good)
	SP (2Hr)	120 min	☆☆☆☆☆
	SPP (2.5Hr)	150 min	☆☆☆☆
	LP (3Hr)	180 min	☆☆☆
	EP (4Hr)	240 min	☆☆
	SLP (6Hr)	360 min	☆ (poor)

- The recording time is only an estimate. The actual recording time may differ.
- The audio and video quality gets poorer as the recording time becomes longer.
- Each time [REC MODE] is pressed, recording mode and its allowed recording time will be displayed.

Note

- **This unit cannot record to CD-RW or CD-R.**
- All high definition pictures will be down converted to the standard definition pictures when they are recorded on this unit.
- DVD+RW/+R, DVD-RW/-R and CD-RW/-R recorded on a personal computer or a DVD or CD recorder may not be played back if the disc is damaged or dirty or if there is condensation on the player's lens.
- If you record a disc using a personal computer, even if it is recorded in a compatible format it may not be played back because of the settings of the application software used to create the disc. (Check with the software publisher for more detailed information.)
- Since the recording is made by the VBR (variable bit rate) method, depending on the picture you are recording, the actual remaining time for recording may be a little shorter than the remaining time displayed on the TV screen.
- You cannot record copy-protected program using this unit. (Copy-protected signal is included in DVD-video or some satellite broadcasts.)
- You cannot record "copy-once only" program on DVD.

Introduction

Connections

Basic Setup

Recording

Playback

Editing

Function Setup

Others

Español

BEFORE RECORDING

Make Recording Compatible



Use this feature to make the unfinalized +VR mode discs recorded on other unit recordable on this unit. When you make an additional recording on this unit with "Make Recording Compatible" set to "ON", the title menu is automatically converted to our style.

1) Press [SETUP] and use [▲ / ▼] to select "General Setting", then press [OK].

"General Setting" menu will appear.

2) Use [▲ / ▼] to select "Recording", then press [OK].

"Recording" menu will appear.

3) Use [▲ / ▼] to select "Make Recording Compatible", then press [OK].

4) Use [▲ / ▼] to select "ON" or "OFF", then press [OK].

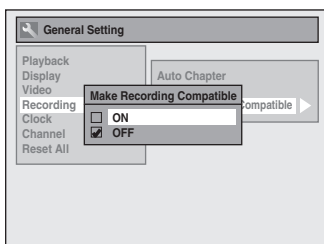

ON: Title list will be replaced when you make additional recordings to the discs recorded by other units.

OFF: Prohibiting additional record to the disc that has a title list created by other units.

5) Press [SETUP] to exit.

Setting for Auto Chapter

You can set a specified time for chapter marks.

1) Press [SETUP] and use [▲ / ▼] to select "General Setting", then press [OK].

"General Setting" menu will appear.

2) Use [▲ / ▼] to select "Recording", then press [OK].

"Recording" menu will appear.

3) Use [▲ / ▼] to select "Auto Chapter", then press [OK].

4) Use [▲ / ▼] to select a desired time option, then press [OK].

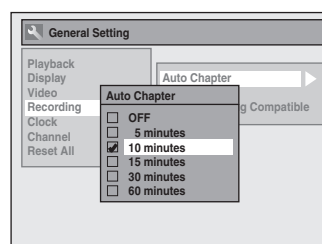

5) Press [SETUP] to exit.

Note

- The interval for auto chapter marks may slightly differ.
- A blank chapter may be created depending on the remaining time of the disc.

BASIC RECORDING & ONE-TOUCH TIMER RECORDING

Follow the steps to record TV programs.



1 Press [STANDBY-ON ].
Turn on the TV and be sure to select the input to which the unit is connected.

2 Press [OPEN/CLOSE ] to open the disc tray and insert your disc with its label facing up.

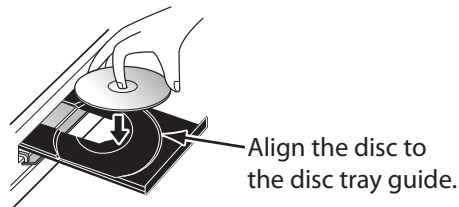

* Make sure the disc is compatible with this unit.
(Refer to page 31 for the list of compatible discs.)

3 Press [OPEN/CLOSE ] to close the disc tray.

It may take a while to load the disc completely.

- When inserting a brand-new DVD+RW/DVD-RW, the unit automatically starts to format.
- If titles have been recorded on the disc, the title list is displayed. Press [STOP ] to exit the title list.

4 Press [REC MODE] to select a recording mode.
Refer to "Recording Mode" on page 31.

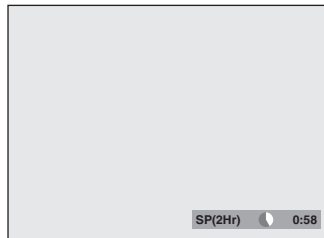

5 Press [DTV/TV] to select analog TV or digital TV, then use [CHANNEL +/-] or [the Number buttons] to select a desired channel to record.

Refer to "Switching Analog Mode/Digital Mode" and "Channel Selection" on page 25.

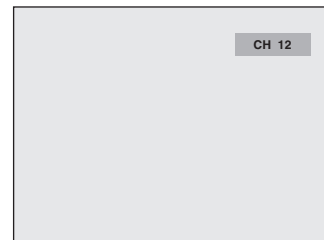

Instructions continue on the next page.

Introduction

Connections

Basic Setup

Recording

Playback

Editing

Function Setup

Others

Español

BASIC RECORDING & ONE-TOUCH TIMER RECORDING

6 Press [REC ●] to start recording. "●" will be displayed for 5 seconds.

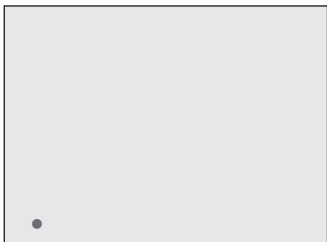

Press [PAUSE ■] to pause recording.
Press [PAUSE ■] or [REC ●] again to restart recording.

To set one-touch timer recording (OTR)...

This is a simple way to set the recording time in blocks of 30 minutes.

Press [REC ●] repeatedly until the desired recording time (30 minutes to 6 hours) appears on the TV screen. One-touch timer recording will start.

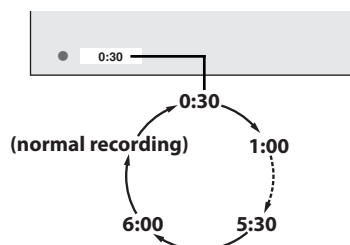

• To cancel one-touch timer recording within the specified time, press [STOP ■].

7 Press [STOP ■] to stop recording. The recorded title will appear in the title list. (Refer to "Guide to a Title List" on page 62.) e.g.) DVD+R

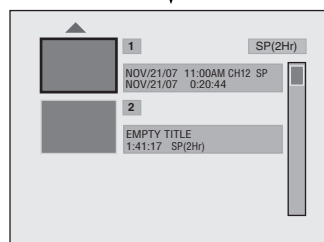
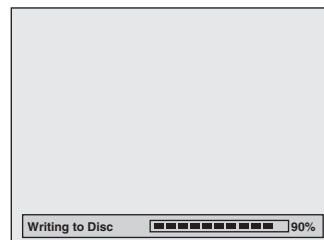

• Press [STOP ■] to exit the title list.

Note

- When you press [REC ●], recording starts immediately and continues until the disc is full or you stop recording.
- This unit cannot record images as aspect ratio of 16:9. The 16:9 images will be recorded as 4:3.
- When the unit clock has not been set, the space for a date and time of title names will be blank.
- When you record a TV program, you have to select the TV channel audio beforehand. Only the selected channel audio will be recorded. Refer to "Selecting TV Audio" on pages 26-27 for more details.
- This unit cannot record in both stereo and SAP (secondary audio program) at the same time.
- You cannot change the recording mode during the recording pause mode.
- You can change a channel to be recorded during the recording pause mode.

Note for one-touch timer recording

- Press [DISPLAY] to see the remaining recording time on the TV screen.
- Unlike the timer recording, you can perform the following operations during one-touch timer recording.
 - Turning off the power to stop one-touch timer recording.
 - Using [REC ●] or [STOP ■] on the remote control.
- You cannot use the pause function during one-touch timer recording.
- When one-touch timer recording is finished and the power is turned off, the unit will switch to the timer-standby mode automatically if a timer recording has been programmed. Press [STANDBY-ON ○] to cancel the timer-standby mode to use the unit continuously.

TIMER RECORDING

You can program the unit to record up to 12 programs within a month in advance. Daily or weekly program recordings are also available.

Before recording, make sure

- Set the clock before setting a timer programming.
- Insert a recordable disc with enough recordable space.



Guide to Timer Programming Display

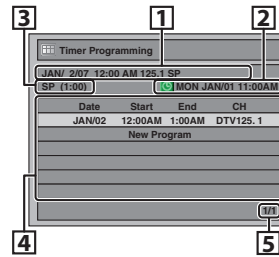

- 1 Title of a timer program (Contains date, time, channel, recording mode of the program)
- 2 Current date and time
- 3 Recording mode, and length of the recording
- 4 Timer program list
- 5 Total number of pages and current page (2 pages maximum)

1 Press [TIMER].

2 Use [▲ / ▼] to select "New Program", then press [OK].

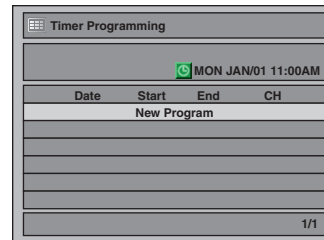

3 Use [▲ / ▼] to enter the date, then press [▶].

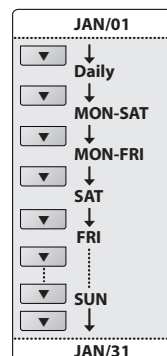
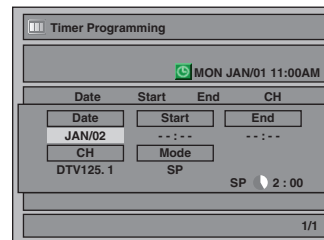

When pressing [▼] at the current date, the date will change as follows.
e.g.) January 1st

Note

- **If you have not set the clock yet:**
"Clock Setting" menu will appear instead of the timer programming list at step 1. Continue with the step 4 in "Manual Clock Setting" on page 24 before setting a timer programming.
- Use [◀ / ▶] to move the cursor to the left and the right in "Timer Programming" menu.

Instructions continue on the next page.

Introduction

Connections

Basic Setup

Recording

Playback

Editing

Function Setup

Others

Español

TIMER RECORDING

- 4** Use [▲ / ▼ / ◀ / ▶] or [the Number buttons] to enter the start and end time, then press [▶].

Date	Start	End
JAN/02	12 : 00AM	- - - -
CH	Mode	
DTV125.1	SP	SP 1 : 00
1/1		

- 5** Use [▲ / ▼ / ◀ / ▶] to select analog (" - - - ") / digital ("DTV") mode or external input (E1 / E2), then press [▶].

e.g.) external input mode

Date	Start	End
JAN/02	12 : 00AM	1 : 00AM
CH	Mode	
E1	SP	SP 1 : 00
1/1		

To record from external input (e.g., cable/satellite box), select E1 or E2.

Use [▲ / ▼] to select the channel number to record.

For digital mode, select both major and minor channels. Refer to "How to select a channel number for the timer recording" on page 37 for more details.

e.g.) analog mode

Date	Start	End
JAN/02	12 : 00AM	1 : 00AM
CH	Mode	
10	SP	SP 1 : 00
1/1		

e.g.) digital mode

Date	Start	End
JAN/02	12 : 00AM	1 : 00AM
CH	Mode	
DTV125.1	SP	SP 1 : 00
1/1		

- 6** Use [▲ / ▼] to select a recording mode.

Date	Start	End
JAN/02	12 : 00AM	1 : 00AM
CH	Mode	
DTV125.1	SP	SP 1 : 00
1/1		

Refer to "Recording Mode" on page 31.

- You can check the remaining recordable space of the disc when you select the recording mode.

Date	Start	End
JAN/02	12 : 00AM	1 : 00AM
CH	Mode	
DTV125.1	SP	SP 1 : 00
1/1		

Auto recording mode select...

When "Auto" is selected as a recording mode, the unit calculates how much time is available on the disc and determines the appropriate recording mode to complete recording the program.

Date	Start	End
JAN/02	12 : 00AM	1 : 00AM
CH	Mode	
DTV125.1	Auto	Auto 0 : 00
1/1		

- "Auto" is only available for one program in the timer program list.
- The recording may be cut short when the available recording space of the disc is too limited.

- 7** Press [OK] when all items are entered.

Your program setting will be stored.

- To set another program, repeat steps 2 to 7.
- To exit, press [TIMER] or [SETUP].
- When 2 or more programs are overlapped, "Timer program overlapped" appears, and the overlapped program will be displayed in blue.
- To correct the timer program refer to "Checking, canceling, or correcting the timer programming information" on page 37.

- 8** Press [STANDBY-ON ⏻] to set a timer programming.

TIMER REC indicator will light up on the front panel.

TIMER RECORDING

How to select a channel number for the timer recording

Analog TV	For channel number 2-6 press, press [▶] or [•] to decide the channels. For other channels (7-69), the channel will be decided as soon as you enter the channel number.
Analog CATV	For channel number 1-12 press, press [▶] or [•] to decide the channels. For other channels (13-125), the channel will be decided as soon as you enter the channel number.
Digital TV	For channel number 1-9 press, press [▶] or [•] to decide the channels. For other channels (10-99), the channel will be decided as soon as you enter the channel number.
Digital CATV	For channel number 1-13 press, press [▶] or [•] to decide the channels. For other channels (14-135), the channel will be decided as soon as you enter the channel number.
minor channels	For channel number 1-9 press, press [▶] or [•] to decide the channels. For other channels (10-99), the channel will be decided as soon as you enter the channel number.

<Hint>

- You can decide the 1-digit channel number by pressing 0 first, then enter desired 1-digit channel number. e.g.) "5": [0]+[5]
- For selecting the channels with [▲ / ▼] you need to press [▶] or [•] to decide the channel number.
- For selecting the minor channels with [▲ / ▼], please make sure the minor channel you are selecting is existed. [▲ / ▼] does not skip the non-existed minor channels.

Checking, canceling, or correcting the timer programming information

- 1) Press [STANDBY-ON ○].
TIMER REC indicator will light off on the front panel.
- 2) Press [TIMER].
- 3) Check the information on the list you will need.

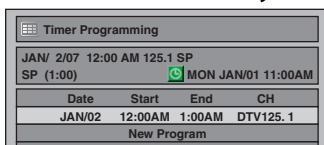

- 4-A) To delete the timer program:
 - 1 Use [▲ / ▼] to select the program you want to delete, then press [OK].
 - 2 Use [▲ / ▼] to select "Delete", then press [OK]. Confirmation window will appear.
 - 3 Use [▲ / ▼] to select "Yes", then press [OK].
- 4-B) To correct the timer program:
 - 1 Use [▲ / ▼] to select the program you want to correct, then press [OK].
 - 2 Use [▲ / ▼] to select "Program Change", then press [OK].
 - 3 Correct the timer program by using [▲ / ▼ / ◀ / ▶], then press [OK].
- 5) Press [TIMER] to exit.
- 6) Press [STANDBY-ON ○] to return to the timer standby mode.

To stop the timer recording in process

Press [STOP ■] on the front panel of the unit.
[STOP ■] on the remote control is not effective.

Note

- Press [TIMER] to check the timer recording in progress. When the timer recording is proceeding, that program will be highlighted with red. In this case, you cannot select any other program.

If the timer program did not complete correctly, the error number appears in the timer programming list.

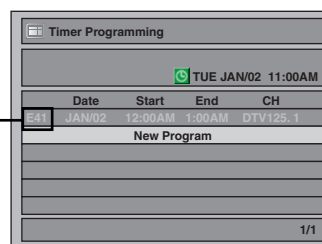

Each error number means:

E1-22 E37-39	Recording error other than below	E41	Power failed
E24	Unrecordable disc	E42	No disc when recording
E25-26	Copy prohibited program	E43	Already 49 titles recorded
E29	Disc protected	E44	Already 254 chapters recorded
E30	Disc full	E45	Copy prohibited program
E35	PCA full *1	E46	It is impossible to record additionally on a disc recorded by other units when setting "Make Recording Compatible" to "OFF".
E36	Already finalized video format disc		
E40	Some portion has not been recorded because of program overlapping. Recording did not start at the start time.		

- E23, E27, E28, E31, E32, E33 and E34 are not displayed.
- A program with the error number is grayed in the timer programming list.
- Once the timer programming list with error line(s) is displayed, or after canceling and setting again the timer standby mode, the program line(s) with error will be cleared.
- *1 PCA is a disc's space reserved for recording test.



TIMER RECORDING

Hints for Timer Recording

- If there is a power failure or this unit has been unplugged for more than 30 seconds, the clock setting and all timer programming will be lost.
- If a disc is not inserted, TIMER REC indicator flashes and timer recording cannot be performed. In some cases, TIMER REC indicator will light up momentarily around the start point as the unit attempts to record. Please insert a recordable disc.
- When all the timer recording is completed, TIMER REC indicator flashes. To play back or eject the recorded disc, press **[STANDBY-ON ○]** first, then select the recorded title and press **[PLAY ▶]**, or **[OPEN/CLOSE ▲]** to remove the disc.
- During timer recording or timer standby mode (TIMER REC indicator will light up), any operations on the unit will not be available. To make these operations available, press **[STOP ■]** on the front panel to cancel the timer recording or **[STANDBY-ON ○]** to release timer standby mode (TIMER REC indicator will light off).
- To cancel the timer standby mode, press **[STANDBY-ON ○]**.
- When the starting and the ending time are the same, the length of the recording will be set for 24 hours. When the disc becomes full during the recording, the unit turns itself off.
- When the programmed starting and ending time are earlier than the current time, the setting will not be accepted and be cleared for redoing.
- If the starting time is earlier and the ending time is later than the current time, the recording will start right after you turn the power off.
- The timer recording for digital TV cannot record any audio language other than English.

The Priority of Overlapped Settings

- Timer program which has the earlier start time will be placed first in the timer program list, and be given priority over the programs with the later start time when timer programs overlap.
- When timer programs overlap, the first 2 minutes (at the longest) of the later recording will be cut off.
- When two or more timer programs have the same start time, the program set first will be given priority.
- A timer recording of lower priority will be canceled or start from the middle.
- Check the overlapped timer programmings and change the priority if necessary.

■ When the starting time is the same:

A program set previously (PROG. A) has priority.

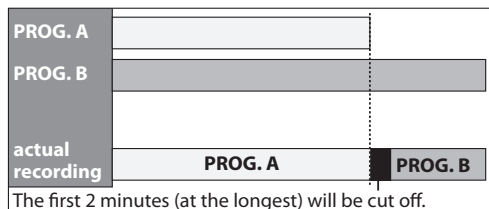

Note for DVD recording

- When the recording time of 2 programs are overlapped, or the end time of a program and the start time of another program is the same, the first 2 minutes (at the longest) of the subsequent program will be cut off.
- If the cut-off portion comes up to 3 minute or more, this program will be displayed with error number E40 in the timer programming list.

■ When the end time of the programming currently being recorded and the start time of the subsequent program are same:

The beginning of the PROG. B may be cut off.

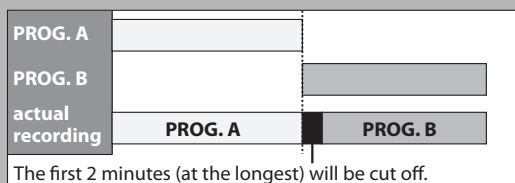

OVERWRITING UNNECESSARY TITLE

Overwriting from the Beginning of the Title



You can overwrite the existing title from the beginning.

- 1) Press **[STANDBY-ON ○]**.
Make sure that the TV input is set on the unit.
- 2) Load the disc that includes a title to be overwritten.

It takes a while to display the title list.

Title list will appear.

If the title list does not appear, press **[TITLE]**.

- 3) Press **[REC MODE]** to select a recording mode.
Refer to "Recording Mode" on page 31.
- 4) Use **[▲ / ▼]** to select a title to be overwritten, then press **[OK]**.

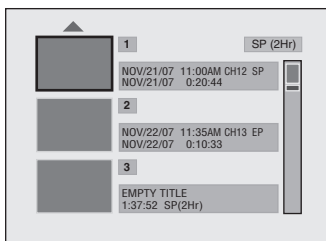

- 5) Use **[▲ / ▼]** to select "Overwrite", then press **[OK]**.

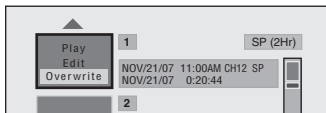

- 6) Select the channel you want to record.
(Refer to page 25 on how to select a channel.)
e.g.) DVD+RW

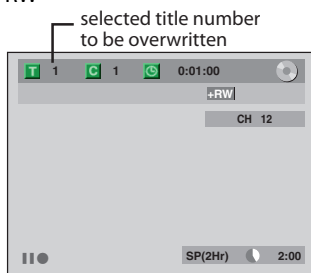

- 7) Press **[REC ●]**.
Overwriting recording starts.
The elapsed-time counter starts running.
- 8) Press **[STOP ■]** to stop recording.
Title name is also overwritten.

This operation may take a while to be completed.

Note

- The remaining recording time is displayed on the bottom right corner of the TV screen during overwriting.

Overwriting in the Middle of the Title



You can overwrite the existing title from the selected position.

- 1) Follow the steps 1, 2 and 4 on the left.
- 2) Use **[▲ / ▼]** to select "Play", then press **[OK]**.
Playback will start.
- 3) Press **[PAUSE II]** at the point from which you want to start overwriting.
- 4) Press **[REC ●]**.
"II●", display menu, channel, and the time lapse will be displayed as illustrated on the left.
- 5) Select the channel you want to record.
(Refer to page 25 on how to select a channel.)
- 6) Press **[REC ●]** again.
Overwriting recording starts.
- 7) Press **[STOP ■]** to stop recording.

This operation may take a while to be completed.

Note

- Recording mode of the overwriting title is the same as that of the original (overwritten) title when overwriting in the middle of the title.
- Title name will not be overwritten.

OVERWRITING UNNECESSARY TITLE

Hints for Overwriting

When you overwrite on the unnecessary title, there were various circumstances such as follows. Please note that following cases only describe the overwriting without any recording mode discrepancy. To avoid accidental deletion please check if there is no important title after the overwriting point.

- When overwriting title is shorter than the existing title:**
(overwriting from the beginning of the title)

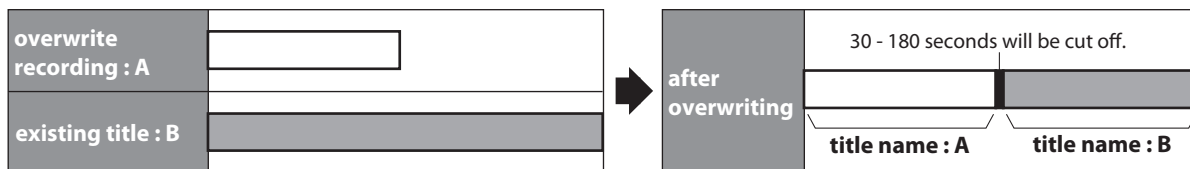

- When overwriting title is longer than the existing title:**
(overwriting from the beginning of the title)

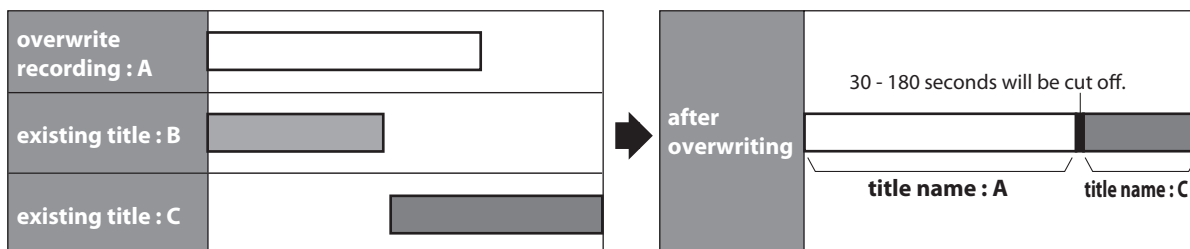
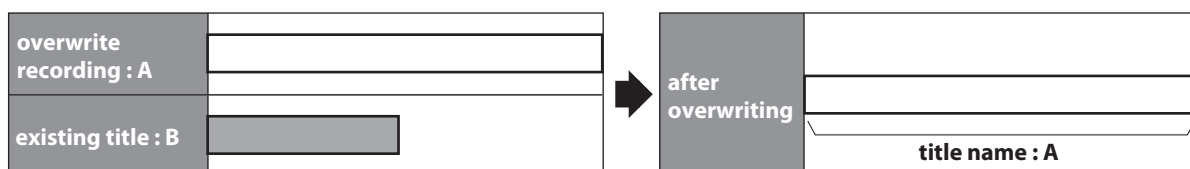

- When overwriting in the middle of the title:**

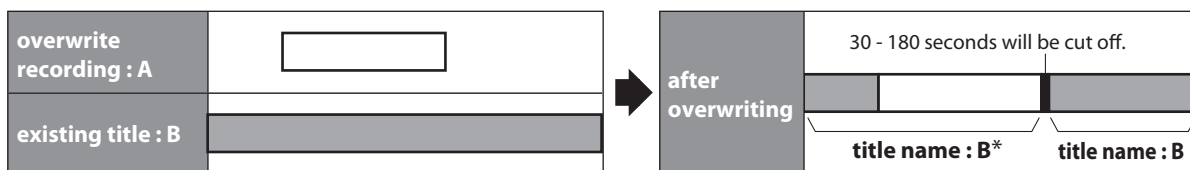

*Overwritten section and the rest of the sections will have the same title name as the original existing title (B).

Note

- When a title name is overwritten, its thumbnail is also overwritten.
- "Auto Chapter" interval time is reset at the overwriting start point.
- A chapter mark is put the beginning of the overwrite title when overwriting in the middle of the title.

SETTINGS FOR AN EXTERNAL DEVICE

Connection to an External Device

Connect the external device properly to the unit by using input jacks either E2 (Front) or E1 (Rear).
When connecting an external device of monaural output to this unit, use AUDIO L jack of E2 (Front).
Use S-video or the RCA audio/video cables for this connection.

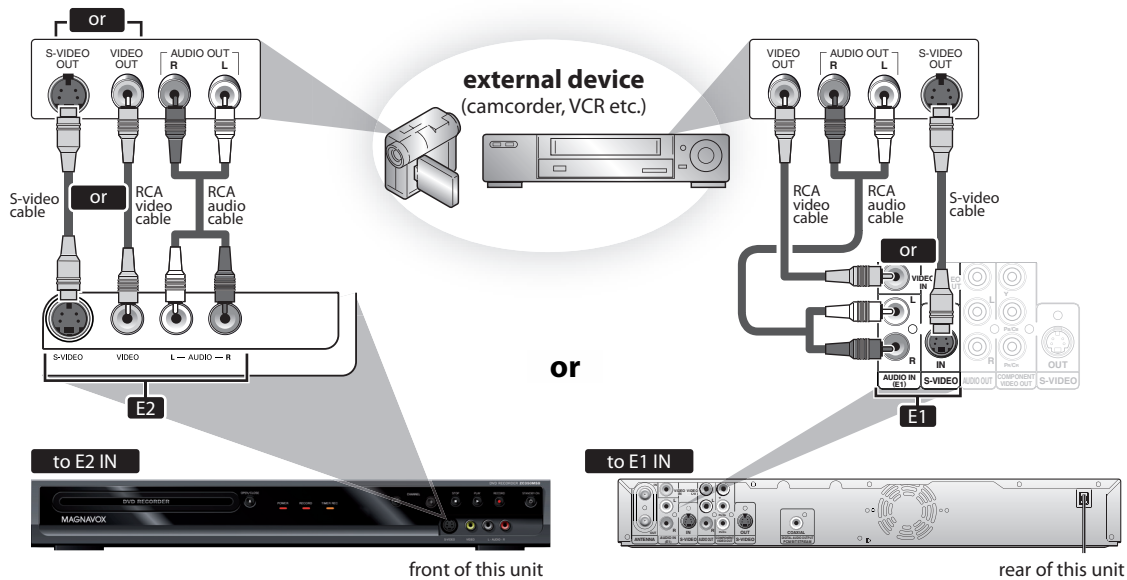

Supplied cables used in this connection are as follows:

- RCA audio cable (L/R) x 1
 - RCA video cable x 1
- Please purchase the rest of the necessary cables at your local store.



1 Press [SETUP] and use [▲ / ▼] to select "General Setting", then press [OK].

"General Setting" menu will appear.

2 Use [▲ / ▼] to select "Video", then press [OK].

Submenu will appear.

3 Use [▲ / ▼] to select "Video Input", then press [OK].

4 Use [▲ / ▼] to select desired external input position, then press [OK].

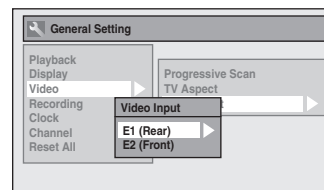

5 Use [▲ / ▼] to select the input jack type to connect, then press [OK].

If you want to use VIDEO IN jack, select "Video In".

If you want to use S-VIDEO IN jack, select "S-Video In".

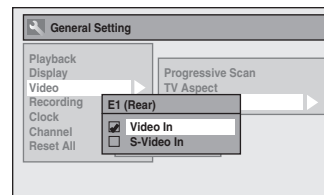

6 Press [SETUP] to exit.

SETTINGS FOR AN EXTERNAL DEVICE

Recording from an External Device

Before recording from an external device, refer to the instructions for the connection on page 41.



1 Turn on the TV and press [STANDBY-ON , and be sure to select the input of the TV to which the unit is connected.

2 Press [OPEN/CLOSE ] to open the disc tray. Place the disc to record properly.

3 Press [OPEN/CLOSE ] to close the disc tray.

It takes a while to load the disc.

4 Select the input of the unit which the external device is connected. (E2 or E1)

- To use the input jacks on the rear of this unit; Select "E1 (Rear)" position by using [SOURCE] or [CHANNEL + / -].
- To use the input jacks on the front of this unit; Select "E2 (Front)" position by using [SOURCE] or [CHANNEL + / -].
- As for E2 and E1, you can also select external input position by using [the Number buttons]. e.g.) For E1, press [0], [0], [1].

5 Press [REC MODE] to select a recording mode.

Refer to "Recording Mode" on page 31.

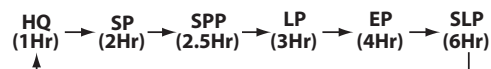

6 Press [RECORD ] on the unit to start recording.

7 Start playback on the external device to record from.

8 Press [STOP ] on the unit to stop recording.

This operation may take a while to be completed.

SETTING A DISC TO PROTECT

To prevent accidental recording, editing or erasing the titles, you can protect them from "Disc Edit" menu.



1 Press [SETUP].

2 Use [▲ / ▼] to select "Disc Edit", then press [OK].

3 Use [▲ / ▼] to select "Disc Protect OFF → ON", then press [OK].
e.g.) DVD+RW

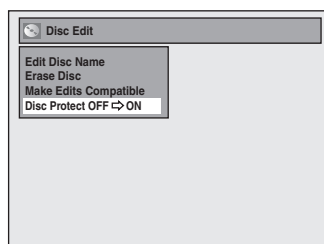

4 Use [▲ / ▼] to select "Yes", then press [OK].

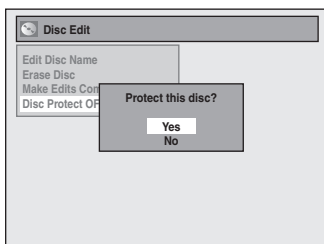

A disc will be protected.

This operation may take a while to be completed.

Note

To cancel the disc protect:

- When you insert a disc protected with this unit, "Disc Protect ON → OFF" will appear instead of "OFF → ON" at step 3.

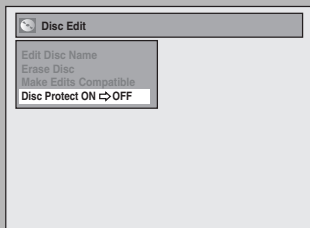

To release the protect for the disc, select "Yes" at step 4.

Introduction

Connections

Basic Setup

Recording

Playback

Editing

Function Setup

Others

Español

PLAYING THE DISCS IN OTHER DVD PLAYERS

Finalizing a Disc



You will need to finalize discs to play back in other DVD players.

Finalizing may take several minutes up to an hour.

A shorter recording period on the disc will require a longer time period for finalization. Do not unplug the power cord during finalization.



1 Press [SETUP].

2 Use [▲ / ▼] to select "Disc Edit", then press [OK].
"Disc Edit" menu will appear.

3 Use [▲ / ▼] to select "Finalize", then press [OK].

4 Use [▲ / ▼] to select "Yes", then press [OK].
e.g.) DVD+R, DVD-R

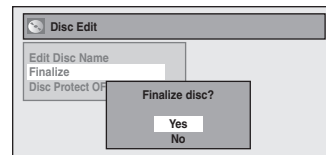

Finalizing will start.



To cancel finalizing...

(DVD-RW only)

- To cancel finalizing at step 4, press [STOP ■], select "Yes" with [▲ / ▼], then press [OK]. Finalizing is canceled and the unit will be in stop mode.

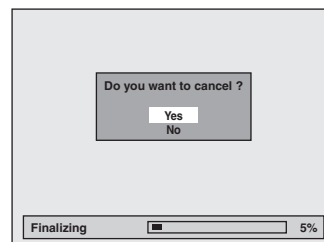

- If ⓪ appears when pressing [STOP ■], you cannot cancel finalizing because the finalizing has been in certain progress.
- When selecting "No" and press [OK] or [RETURN], finalizing will be continued.
- You cannot cancel finalizing the DVD+R/DVD-R once it has started.

This operation may take a while to be completed.

Note

- Once you have finalized a DVD+R/ DVD-R, you cannot edit or record anything on that disc.
- There is no need to finalize DVD+RW.
- When you insert a DVD-RW finalized with this unit, "Undo Finalize" will appear instead of "Finalize".

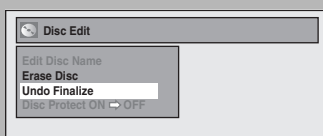

To release the finalizing for the disc, select "Undo Finalize" at step 3.

* DO NOT power off during finalization, this will result in malfunction.

5 Finalizing is completed.

PLAYING THE DISCS IN OTHER DVD PLAYERS

Auto Finalizing



You can finalize discs automatically using this function. You can use this function to finalize discs after finishing all timer recordings and at the end of the disc space.



1 Press [SETUP] and use [▲ / ▼] to select "General Setting", then press [OK].

"General Setting" menu will appear.

2 Use [▲ / ▼] to select "Recording", then press [OK].

"Recording" menu will appear.

3 Use [▲ / ▼] to select "Auto Finalize", then press [OK].

4 Use [▲ / ▼] to select "Disc Full" or "End of Timer Rec", then press [OK].

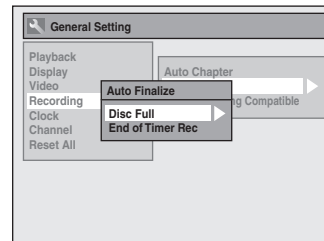

5 Use [▲ / ▼] to select "ON", then press [OK].

e.g.) "Disc Full"

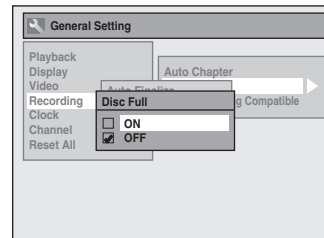

Your setting will be activated.













6 Press [SETUP] to exit.

INFORMATION ON PLAYBACK

Before you play back DVD, read the following information.

Playable Discs and Files

This unit is compatible to play back the following discs. To play back a DVD, make sure that it meets the requirements for region codes and color systems as described below. You can play back discs that have the following logos will play back on the unit. Other disc types are not guaranteed to play back.

Playable discs	Logos
DVD-video	
DVD+RW	
DVD+R	
DVD-RW (Finalized video mode discs only)	
DVD-R (Finalized video mode discs only)	
CD-DA (audio CD)	
video CD	 
CD-RW	 
CD-R	 

Playable files	Media
CD-DA	CD-RW/-R
MP3	

 is a trademark of DVD Format/Logo Licensing Corporation.

Unplayable Discs

The following discs will not play back on this unit.

- CD-ROM
- DVD-RAM
- DVD-ROM
- Unfinalized disc
- DVD contains MP3 and DVD or CD contains Windows Media™ Audio/JPEG files
- DVD-R or DVD-RW recorded in VR mode or non compatible recording format
- Compact Disc-Interactive (CD-I)
- Video Single Disc (VSD)
- DVD-audio

On the following disc, the sound may not be heard.

- Super audio CD - Only the sound on the CD layer can be heard. The sound on the high-density super audio CD layer cannot be heard.

Color Systems

DVD is recorded in different color systems throughout the world. The most common color system is NTSC (which is used primarily in the United States and Canada). This unit uses NTSC, so DVD you play back must be recorded in the NTSC system. You cannot play back DVD recorded in other color systems.

Region Codes

This unit has been designed to play back DVD with region 1. DVD must be labeled for ALL regions or for region 1 in order to play back on the unit. You cannot play back DVD that are labeled for other regions. Look for the symbols on the right on your DVD. If these region symbols do not appear on your DVD, you cannot play back the DVD in this unit.



The number inside the globe refers to region of the world.

A DVD labeled for a specific region can only play back on the unit with the same region code.

INFORMATION ON PLAYBACK

PBC (playback control) for Video CD

You can select images or information on the menu screen by activating the PBC (playback control) function of the video CD.

This unit conforms to ver.1.1 and ver. 2.0 of video CD standard with PBC function.

Ver.1.1 (without PBC function): You can enjoy playback picture as well as music CD.

Ver.2.0 (with PBC function): While using a video CD with PBC function, "PBC" appears on the TV screen.

Note

- PBC setting turns to "ON" when loading video CD with PBC function, thus, even after setting PBC to "OFF" and ejecting the video CD then reloading the video CD, this setting turns to "ON" automatically.
- Some operations cannot be performed while PBC function is on. Cancel PBC function temporarily to perform those operations by following the instruction below.

- 1) Press [SETUP].
- 2) Use [▲ / ▼] to select "CD Playback Mode", then press [OK].
"CD Playback Mode" menu will appear.
- 3) Use [▲ / ▼] to select "PBC (Video CD only)", then press [OK].
- 4) Use [▲ / ▼] to select "ON" or "OFF", then press [OK].
Your setting will be activated.

You can play back interactive software using menu screens. Refer to instructions in the video CD.

Hint for DVD Playback

The contents of DVD are generally divided into titles. Titles may be further subdivided into chapters.

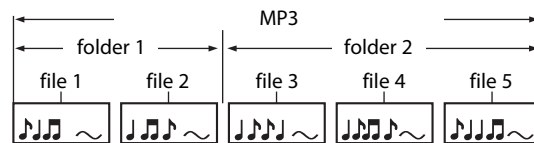
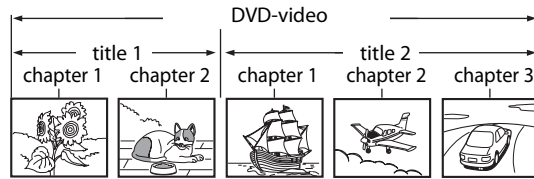

Introduction

Connections

Basic Setup

Recording

Playback

Editing

Function Setup

Others

Español

BASIC PLAYBACK

Direct Playback



1 Press [STANDBY-ON].
Turn on the TV and be sure to select the input to which the unit is connected.

2 Press [OPEN/CLOSE] to open the disc tray and insert your disc with its label facing up.

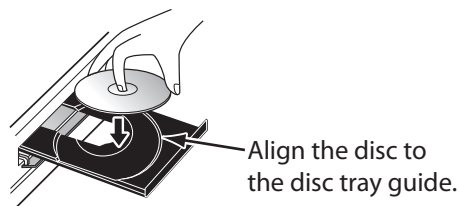

* Make sure the disc is compatible with this unit.
(Refer to page 46 for the list of compatible discs.)

3 Press [OPEN/CLOSE] to close the disc tray.

It may take a while to load the disc completely.

4 Press [PLAY] to start playback.
If you are playing back a DVD-video or video CD with PBC function, a menu may appear.
Refer to "Using the Title / Disc Menu" on page 52.

5 Press [STOP] once to stop playback temporarily.
• Refer to "Resume Playback" on page 53.

Note

- Some discs may start playback automatically.
- You can select images or information on the menu screen by activating PBC (playback control) function (page 47).

BASIC PLAYBACK

Playback from the Title List



1 Press [STANDBY-ON ].
Turn on the TV and be sure to select the input to which the unit is connected.

2 Press [OPEN/CLOSE ] to open the disc tray and insert your disc with its label facing up.

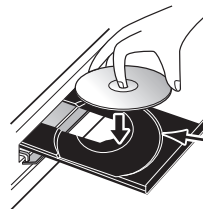

Align the disc to the disc tray guide.

* Make sure the disc is compatible with this unit.
(Refer to page 46 for the list of compatible discs.)

3 Press [OPEN/CLOSE ] to close the disc tray.

It may take a while to load the disc completely.

- To exit the title list, press [STOP ].
- To resume the title list, press [TITLE].

Note

- Some discs may start playback automatically.
- You can also start playback by pressing [PLAY ] instead of [OK] at step 4.

Introduction

Connections

Basic Setup

Recording

Playback

Editing

Function Setup

Others

Español

BASIC PLAYBACK

4 Use [▲ / ▼] to select a desired title, then press [OK].

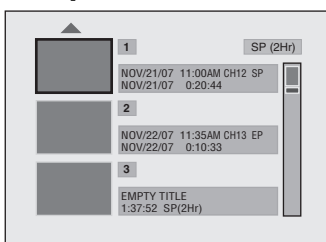

- For Video CD, when "PBC (Video CD only)" in "CD playback Mode" menu is set to "ON", the video CD main menu will appear when inserting a disc. In such case, select a numbered menu with **[the Number buttons]**.
- Press [▶] to display the next page, and press [◀] to display the previous page.

5 Use [▲ / ▼] to select "Play", then press [OK].



Playback will start.

6 Press [STOP ■] once to stop playback temporarily.

- Refer to "Resume Playback" on page 53.
- To eject the disc, press [OPEN/CLOSE ▲] to open the disc tray, then remove the disc before turning off the unit.

If you want to see disc information, press [◀] when the first page of the title list is displayed or press [▲] when the first title is selected but not when "Play", "Edit" or "Overwrite" is highlighted.

e.g.) DVD+RW

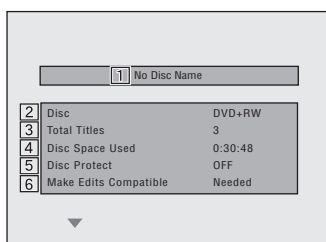

e.g.) DVD+R

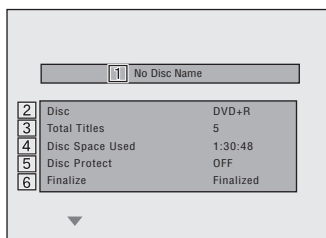

1. Disc name
(Default "No Disc Name")
2. Disc type
(DVD+RW/DVD+R/ DVD-RW/DVD-R)
3. Total number of title
(include "EMPTY TITLE")
4. Total time of recorded disc space
5. Status of disc protection
(“ON” is protected disc.)
6. Making edits compatible/finalize
 - When DVD+RW is inserted:
If the disc needs to be set "Make Edits Compatible", "Needed" is displayed. Otherwise, "Not Needed" is displayed. (Refer to page 74.)
 - When DVD+R, DVD-RW or DVD-R is inserted:
If "Finalize" is done, "Finalized" is displayed. Otherwise, "Unfinalized" is displayed.

BASIC PLAYBACK

Playing Back an Audio CD and a CD-RW/-R with MP3 Files



1 Follow steps 1 to 2 in “Direct Playback” on page 48.

2 Press [OPEN/CLOSE ▲] to close the disc tray.

It may take a while to load the disc completely.

When an audio CD is inserted, track list will appear.

When a CD-RW/-R with MP3 files is inserted, file list will appear.

- To exit the track/file list, press [STOP ■].
- To resume the track/file list, press [TITLE].

3 Use [▲ / ▼] to select a desired folder or track/file, then press [OK].
e.g.) File list

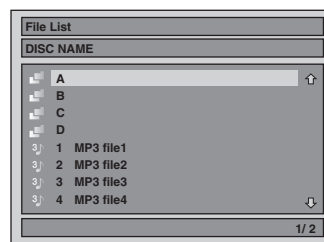

When selecting track/file:

Playback will start.

When selecting the folder (Not available for audio CD):

The files in the folder will appear.

Use [▲ / ▼] to select the file or folder you want to play back, then press [OK].

- Press [PLAY ►], [OK] or [►] to move to any lower hierarchies.
- Press [◀] or [RETURN] to move back to the previous hierarchy.

Hints for audio CD tracks and MP3 files:

- Folders are shown by [📁].
- Audio CD tracks are shown by [🎵].
- MP3 files are shown by [🎵].
- The system can recognize up to 255 folders, up to 99 tracks/999 files.
- Letters of a file/folder name overflowing the given space will be displayed as "...". Unrecognizable characters will be replaced with asterisks.
- If there are no files in the folder, "No Files" will be displayed.

It is recommended that files to be played back in this unit are recorded under the following specifications:

<MP3>

- Sampling frequency : 44.1 kHz or 48 kHz.
- Constant bit rate : 112 kbps - 320 kbps

Note

- The audio source of MP3 files cannot be recorded as digital sound by an MD or DAT deck.
- Files whose extension is other than ".mp3(MP3)" will not be listed.
- Some unplayable folders or files may be listed due to the recording status.



BASIC PLAYBACK

Using the Title / Disc Menu



DVD or video CD with PBC function may contain a title list, which describes the contents of the disc, or a disc menu, which guides you through the available functions in the disc.

- 1) Press [TITLE] or [DISC MENU] to call up the title list or disc menu.
- 2) Use [▲ / ▼ / ◀ / ▶] to make a selection, and then press [OK] to enable your selection.
- 3) Press [STOP ■] to exit.

Note

- You can select a numbered menu with [the Number buttons] also.
- Menus vary among discs. Refer to the information accompanying the disc for details.
- [TITLE] or [DISC MENU] will not always be active with all DVD.
- For video CD, when "PBC (Video CD only)" in "CD Playback Mode" menu is "ON", the video CD main menu will appear when inserting a disc.

Pause

- 1) During playback, press [PAUSE II].

Playback will be paused and sound will be muted.

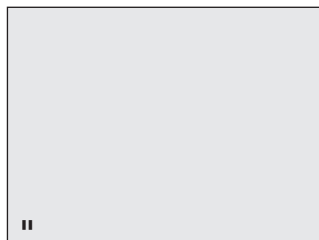

- 2) Press [PLAY ►] to return to the normal playback.

Note

- On DVD, set "Still Mode" to "Field" in "Playback" menu if pictures in the pause mode are blurred. (Refer to page 80.)



SPECIAL PLAYBACK

Resume Playback

You can play back from where you stopped playing back the disc last.

1) During playback, press [STOP ■].

The resume message will appear.



2) Press [PLAY ►].

In a few seconds, playback will resume from the point at which it stopped last. You can resume playback at the same point even if you turn off the unit.

To cancel the resume playback and start playing back the disc from the beginning, press [STOP ■] again while the playback is stopped.

Note

- For MP3 files, playback will resume from the beginning of the file at which playback was stopped.
- Some video CD with the PBC function resume playback from the beginning of the track.

Fast Forward / Fast Reverse Playback



1) During playback, press [►►] or [◄◄].

Every time you press [►►] or [◄◄], approximate speed will be changed as follows.

Fast forward or fast reverse playback across titles (for DVD) or files (for MP3 files) is not possible.



For video CD, approximate forward/reverse speeds are 2x, 8x, 16x.

For audio CD, MP3 files, approximate speed is fixed at 8x with sound (indicated with ►►►► / ◄◄◄◄).

2) Press [PLAY ►] to return to the normal playback.

Note

- Forward/reverse speed will be indicated with icons as follows.

forward (approx. speed)

2x: ►►

20x: ►►►

40x: ►►►►

reverse (approx. speed)

5x: ◄◄

20x: ◄◄◄

40x: ◄◄◄◄

Skipping TV Commercials During Playback



You can skip TV commercials to enjoy the recorded programs without interrupting.

During playback, press [CM SKIP].

Normal playback will start at 30 seconds ahead from the point you press [CM SKIP].

Every time you press [CM SKIP], the searching point will be extended by 30 seconds ahead.

You can press [CM SKIP] up to 6 times (180 seconds).

e.g.) Press [CM SKIP] once.

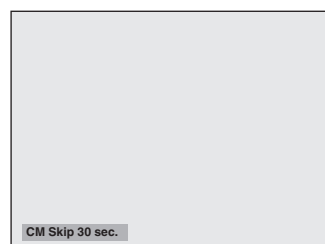

(forwarding 30 seconds)

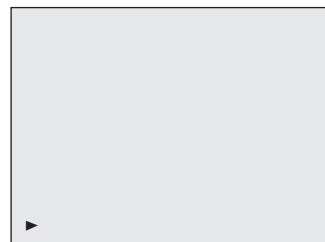

Playback will return to the normal playback.

Introduction

Connections

Basic Setup

Recording

Playback

Editing

Function Setup

Others

Español

SPECIAL PLAYBACK

Rapid Playback



Rapid playback function is available only during playback.

This function is available only on discs recorded in the Dolby Digital format, and plays back in a slightly faster/slower speed while keeping the sound quality just as normal playback.

1) During playback, press [RAPID PLAY].

- ▶ : Press [RAPID PLAY] once during playback. Plays back approximately at 0.8 times of normal playback.
- ▶ : Press [RAPID PLAY] twice during playback. Plays back approximately at 1.3 times of normal playback.
- ▶ : Press [RAPID PLAY] 3 times to play back in normal speed. No effects.

2) Press [PLAY ►] to continue the normal playback.

Note

- Audio (language) setting cannot be changed while using this mode.
- This feature may not work at some point in a disc.
- Audio is PCM during rapid playback mode except when using digital audio connection.
- When using digital audio connection (COAXIAL), the LPCM sound (2 channel) will be output.

Step by Step Playback



1) During playback, press [PAUSE II].

Playback will be paused and sound will be muted.

2) Press [►►] repeatedly.

Playback will advance one frame (or step) at a time when you press [►►] with the sound muted.

To play back step by step backward:

Press [◄◄] repeatedly.

Every time you press the button, the playback will go backward by one frame.

- Press and hold [◄◄] / [►►] to reverse/ advance continuously.

3) Press [PLAY ►] to continue the normal playback.

Note

- Only step by step forward playback is available for playing back video CD.

Slow Forward / Slow Reverse Playback



1) During playback, press [PAUSE II]. Then press [►►] or [◄◄].

Every time you press [►►] or [◄◄], approximate speed will be changed as follows. (The sound will remain muted.)

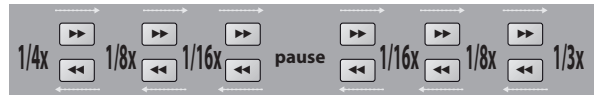

To return to the normal playback, press [PLAY ►].

Note

- Forward/reverse speed will be indicated with icons as follows.
 - forward (approx. speed)
 - 1/16x:
 - 1/8x:
 - 1/3x:
 - reverse (approx. speed)
 - 1/16x:
 - 1/8x:
 - 1/4x:
- Only slow forward is available when playing back video CD.

SPECIAL PLAYBACK

Zoom



1) During playback, press [DISPLAY].

2) Use [◀/▶] to select , then press [OK] within 1 second or wait for 1 second to display the selection menu.

e.g.) DVD-video

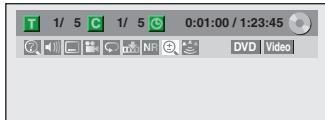

3) Use [▲/▼] to select a desired zoom factor to zoom, then press [OK].

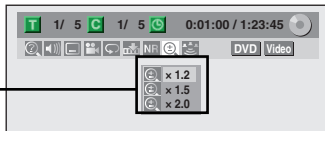

Zoom menu will appear.

There are four options

(x1.0, x1.2, x1.5 and x2.0), these are displayed excluding the current zoom rate.

Zoom area will be displayed.

4) Use [▲/▼/◀/▶] to select a desired zoom position, then press [OK].

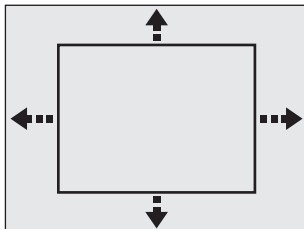

Zoom playback will start.

Note

- When selecting a smaller factor than the current one, the zoom area will not be displayed.
- To exit the zoom menu, press [DISPLAY] again at step 1.
- To cancel the zoom function, select "x1.0" using [▲/▼], then press [OK].

Marker Setting



This feature allows you to assign a specific point on a disc to be called back later.

1) During playback, press [DISPLAY].

2) Use [◀/▶] to select , then press [OK] within 1 second or wait for 1 second to display the marker list.

e.g.) DVD-video

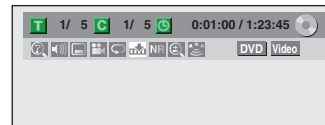

3) Use [▲/▼] to select a desired marker number. When it reaches the desired point, press [OK].

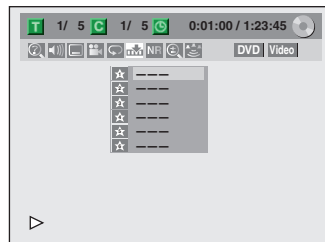

The title (track) number and the time will be displayed.

4) To return to the marker later:

Use [▲/▼] to select the desired marker number, then press [OK].

Note

- To clear a marker, select the marker number to be cleared, then press [CLEAR].
- All markers will be erased when you operate these operations listed below.
 - Opening the disc tray
 - Turning off the power
 - Record on a recordable disc
- You can mark up to 6 points.
- Marker setting is not available when you play back the video CD with PBC function.

Introduction

Connections

Basic Setup

Recording

Playback

Editing

Function Setup

Others

Español

SEARCH

Title / Chapter Search



Using [◀◀] / [▶▶]

- 1) During playback, press [▶▶] to skip the current title or chapter and move to the next.

The title or chapter will move forward by one at a time.

- If there is no chapter in one title, the current title will be skipped.

To go back to the beginning of the current title or chapter, press [◀◀].

Press it repeatedly to go to the previous title or chapter. The title or chapter will move backward one at a time.

Using [DISPLAY]

- 1) During playback, press [DISPLAY].

- 2) Use [◀/▶] to select , then press [OK].

e.g.) DVD-video

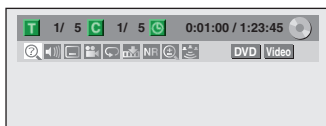

The number next to **T** will be highlighted.

- 3) Title:

Use [▲ / ▼] or [the Number buttons] to enter a desired title number to search, then press [OK].

Title search will start.

Chapter:

Press [▶] to move to the number next to **C** for chapter.

Use [▲ / ▼] or [the Number buttons] to enter a desired chapter number to search, then press [OK].

After the search, playback will start automatically.

Note

- In search mode display, total numbers of each search contents (title/chapter/time) are shown as a denominator.

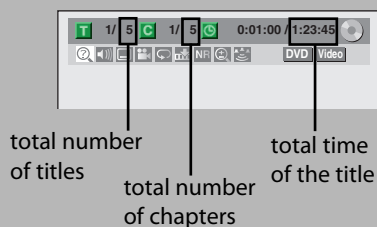

Track Search



Using [◀◀] / [▶▶]

- 1) During playback, press [▶▶] to skip the current track/file and move to the next.

The track/file will move forward one at a time.

To go back to the beginning of the current track/file, press [◀◀].

Press it repeatedly to go to the previous track/file. The track/file will move backward one at a time.

Using [DISPLAY]

- 1) During playback, press [DISPLAY].

- 2) Use [◀/▶] to select , then press [OK].

e.g.) audio CD

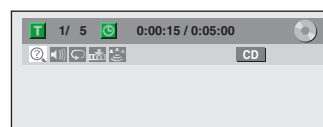

e.g.) MP3 files

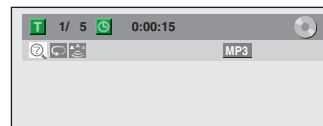

The number next to **T** will be highlighted.

- 3) Use [▲ / ▼] or [the Number buttons] to enter a desired track/file number to search, then press [OK].

After the search, playback will start automatically.

Note

- During CD playback you can enter a track number directly using [the Number buttons] for track search without displaying the menu.
- Track search is not available when you play back the video CD with PBC function.

SEARCH

Time Search



1) During playback, press [DISPLAY].

2) Use [◀/▶] to select , then press [OK].

e.g.) DVD-video

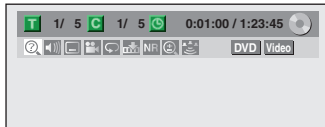

e.g.) audio CD

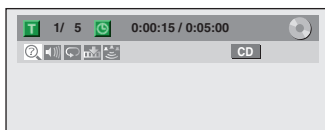

The number next to **T** will be highlighted.

To move to the number next to , press [▶].

When time search is not available,  and time counter are not displayed.

3) Use [▲ / ▼ / ◀ / ▶] or [the Number buttons] to enter a desired time to search, then press [OK].

After the search, playback will start automatically.

Note

- Time search is available only in the same track, file or title.
- Time search is not available when you play back the video CD with PBC function.

Introduction

Connections

Basic Setup

Recording

Playback

Editing

Function Setup

Others

Español

REPEAT / RANDOM / PROGRAM PLAYBACK

Repeat Playback

Available repeat function may vary depending the discs.

1) During playback press [DISPLAY].

2) Use [◀/▶] to select , then press [OK] within 1 second or wait for 1 second to display the selection menu.



3) Use [▲/▼] to select a desired option to repeat, then press [OK].

e.g.) DVD-video

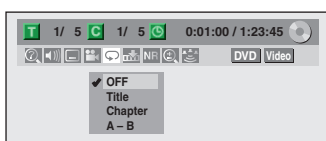

e.g.) audio CD, video CD

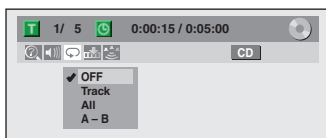

e.g.) MP3 files

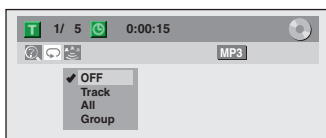

The selected repeat playback will start.

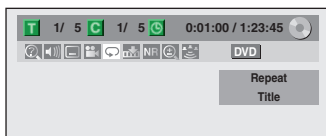

Title:

The current title will be played back repeatedly.

Chapter:

The current chapter will be played back repeatedly.

All:

The current disc will be played back repeatedly.

A-B:

Desired section can be played back repeatedly.

1) Use [▲/▼] to select "A-B", then press [OK].

2) Press [OK] at the desired starting point A.

3) Press [OK] at the desired ending point B.

Track:

The current track or file will be played back repeatedly.

Group:

The current folder will be played back repeatedly.

Note

- Point B for the repeat A-B playback should be set within the same title or track as point A.
- To cancel the repeat playback, select "OFF" at step 3. The repeat setting will also be canceled when you stop playback.
- You cannot select "Group" during the random playback of MP3 files.
- Repeat playback is not available when you play back the video CD with PBC function.

Random Playback



You can play back a disc randomly instead of playing back in the original order.

1) Press [SETUP].

2) Use [▲/▼] to select "CD Playback Mode", then press [OK].

"CD Playback Mode" menu will appear.

3) Use [▲/▼] to select "Random Play", then press [OK].

Random playback will start.

Note

- To cancel random playback, press [STOP ■] twice during random playback. "OFF" appears on the TV screen.
- For video CD with PBC function, the PBC setting will be switched to off automatically when you start random playback.

REPEAT / RANDOM / PROGRAM PLAYBACK

Program Playback



You can program the disc to play back in your desired order.

- 1) Press [SETUP].
- 2) Use [▲ / ▼] to select "CD Playback Mode", then press [OK].
"CD Playback Mode" menu will appear.
- 3) Use [▲ / ▼] to select "Program Play", then press [OK].
- 4) Use [▲ / ▼] to select a desired track, then press [OK] or [▶].

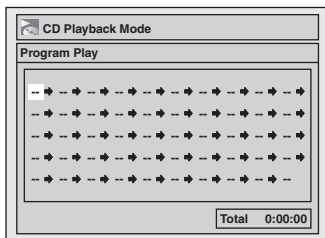

Repeat this step until you program all the desired tracks.

- 5) Press [PLAY ▶].

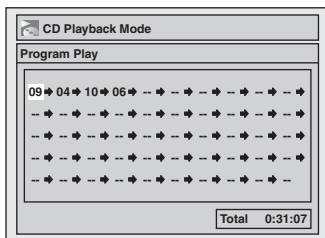

Program playback will start.

Note

- To erase tracks you selected, press [CLEAR] at step 4.
- You can make program settings up to 50 tracks.
- To cancel program playback, press [STOP ■] twice during program playback. "OFF" appears on the TV screen.
- You may also select a desired track using [the Number buttons] at step 4.
- For video CD with PBC function, the PBC setting will be switched to off automatically when you start program playback.

Introduction

Connections

Basic Setup

Recording

Playback

Editing

Function Setup

Others

Español

SELECTING THE FORMAT OF AUDIO AND VIDEO

You can select the format of audio and video as you prefer depending on the contents of the disc you are playing back.

Switching Subtitles



DVD-video may have subtitles in 1 or more languages. Available subtitle languages can be found on the disc case. You can switch subtitle languages anytime during playback.

1) During playback, press [DISPLAY].

2) Use [◀/▶] to select , then press [OK] within 1 second or wait for 1 second to display the selection menu.

e.g.) DVD-video

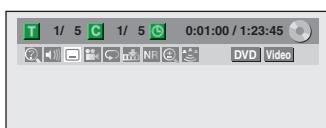

3) Use [▲/▼] to select a desired subtitle language, then press [OK].

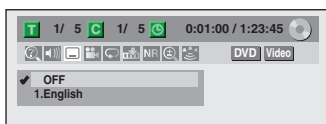

Subtitle will be displayed in the selected language. When selecting "OFF", subtitle will disappear.

Note

- Some discs will only allow you to change the subtitle from the disc menu. Press [TITLE] or [DISC MENU] to display the disc menu.
- If a 4-digit language code appears in the subtitle menu, refer to the "LANGUAGE CODE" on page 91.

Switching Audio Soundtrack



When playing back a DVD-video recorded with 2 or more soundtracks (these are often in different languages), you can switch them during playback.

When playing back video CD, audio CD you can switch "L/R"(stereo), "L"(left) or "R"(right).

1) During playback press [DISPLAY], then proceed to step 2), or press [AUDIO] then proceed to step 3).

2) Use [◀/▶] to select , then press [OK] within 1 second or wait for 1 second to display the selection menu.

3) Use [▲/▼] to select a desired audio soundtrack or audio channel, then press [OK].

For DVD-video

- Audio soundtrack will switch.

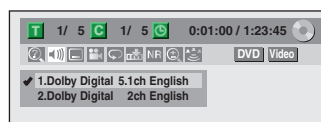

- If the title contains both main and sub audio, you can further select "L" (main), "R" (sub), or "L/R" (mixed of main and sub).

For audio CD, video CD

- Audio channel will switch.

e.g.) audio CD

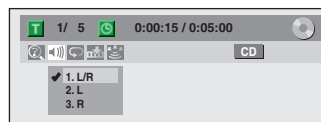

Note

- Some discs will only allow you to change the soundtrack from the disc menu. Press [TITLE] or [DISC MENU] to display the disc menu.

SELECTING THE FORMAT OF AUDIO AND VIDEO

Switching Virtual Surround System



You can enjoy stereophonic virtual space through your existing 2 channel stereo system.

- 1) During playback, press [DISPLAY].
- 2) Use [◀/▶] to select , then press [OK] within 1 second or wait for 1 second to display the selection menu.
e.g.) DVD-video

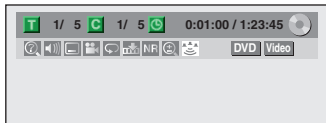

- 3) Use [▲/▼] to select "OFF", "Type 1" or "Type 2", then press [OK].
e.g.) DVD-video

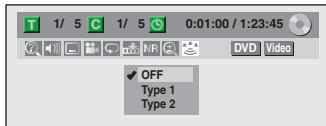

- OFF** : no effect
Type 1 : natural effect
Type 2 : emphasized effect

Note

- Select "OFF" in a case sound is distorted.
- The setting will be kept even when the unit is turned off.

Switching Camera Angles



Some DVD-video have scenes shot from 2 or more angles. Angle information should be on the disc case if the disc contains multi-angle scenes.

- 1) During playback, press [DISPLAY].
- 2) Use [◀/▶] to select , then press [OK].
e.g.) DVD-video

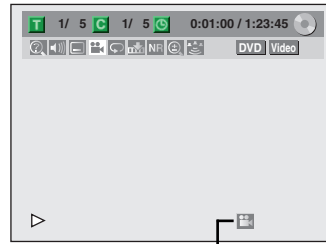

Angle icon appears when a switching camera angle is available.

Angle will switch each time you press [OK].

Note

- Angle icon does not appear on the TV screen in a case you set "Angle Icon" to "OFF" in "Playback" menu. Refer to page 80.

Reducing Block Noise



- 1) During playback, press [DISPLAY].
- 2) Use [◀/▶] to select **NR**, then press [OK] within 1 second or wait for 1 second to display the selection menu.
e.g.) DVD-video



- 3) Use [▲/▼] to select a desired option, then press [OK].

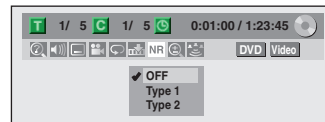

Your setting will be activated.

This function reduces noise in the playback picture. If noises appear on the TV screen during playing back discs recorded in long time recording mode such as EP or SLP, select "Type 1" or "Type 2". ("Type 2" is more effective.)

When playing back discs with a few noises such as DVD-video, select "OFF".

INFORMATION ON DISC EDITING

Guide to a Title List

Title list allows you to check the titles recorded on the disc easily. You can choose a title to play back from this list and easily edit the titles as you prefer.

Press [TITLE].

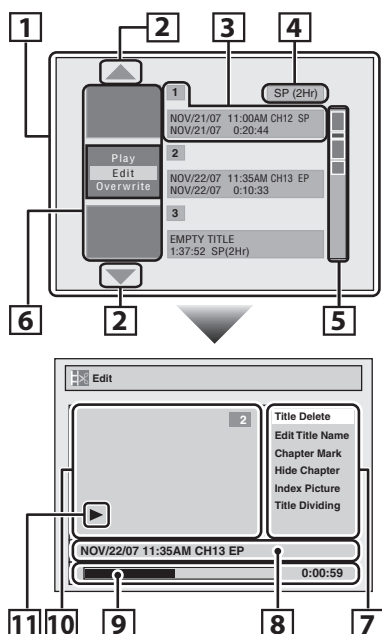

1. **Title list:** List of the titles recorded on the disc, and their information.
2. **Arrow:** Indicating there is a previous / next page.
3. **Title information:** On the first line, title name (editable) is displayed. On the second line, the length of the title is displayed.
Empty title: The portion of the disc where there is no recordings are made. As for the empty title, available recording time by the selected recording mode is displayed on the second line.
4. **Recording mode:** Currently selected recording mode is displayed here.
5. **Capacity indicator:** Indicating the position and the amount of each title in the disc. The portion for the selected title is highlighted.
6. **Thumbnails:** A cut from the recorded content is displayed here.
7. **Submenu:** Submenus for the selected menu are displayed here.
8. **Title name (editable):** If you do not name the title, the recorded date, time, channel, and the recording mode are displayed here.
9. **Progress bar:** Indicating the progress of the playback.
10. **Preview window:** Preview of the selected title is displayed here.
11. **Playback status:** Indicating the current playback status of the selected title.

Press [STOP ■] to exit the title list.

Editing Discs

You can edit discs for the following items. Be sure that once you edit titles, they will not remain as original.

- Deleting Titles (Refer to page 63.)
- Putting Names on Titles (Refer to page 64.)
- Setting Chapter Marks (Refer to page 65.)
- Clearing Chapter Marks (Refer to pages 66-67.)
- Hiding Chapters (Refer to page 68.)
- Setting Pictures for Thumbnails (Refer to page 69.)
- Dividing a Title (DVD+RW/DVD-RW only) (Refer to page 70.)
- Putting Name on Disc (Refer to page 71.)
- Setting or Releasing Disc Protect (Refer to page 72.)
- Erasing Disc (Refer to page 73.)
- Making Edits Compatible (Refer to page 74.)

Note

- When selecting "Edit" on pop-up menu of the title list and edit the title, the title list is displayed after writing the edited contents onto the disc.
- The capacity indicator in the right side of the title list may not indicate the precise capacity in the disc.
- The capacity indicator may not indicate the capacity for the titles of which recording time is short.
- Once you have finalized a DVD+R/ DVD-R, you cannot edit or record anything on that disc.

EDITING DISCS

Deleting Titles

You can delete titles which you do not need anymore. Please be advised that the titles once deleted cannot be brought back to the disc.

For DVD+RW/DVD-RW, when the last recorded title in the title list is deleted, the available disc space to record on will be increased. For DVD+R/DVD-R, the disc space to record on will not be changed.



1 Press [TITLE].

2 Use [▲ / ▼] to select a desired title, then press [OK].

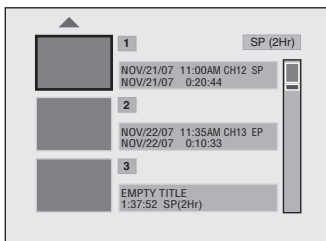

Note

- Deleted part of the titles in the capacity indicator changes in color.
- As for DVD+RW/DVD-RW if you delete the title, deleted title will be displayed as "EMPTY TITLE".

3 Use [▲ / ▼] to select "Edit", then press [OK].



4 Use [▲ / ▼] to select "Title Delete", then press [OK].

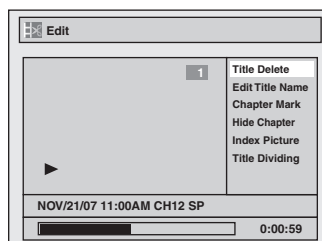

5 Use [▲ / ▼] to select "Yes", then press [OK].

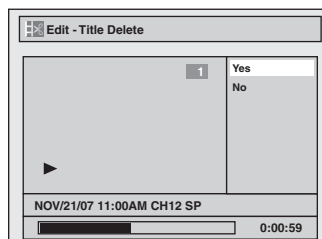

After that, "Are you sure?" will appear, select "Yes" and then press [OK].

Title will be deleted.

Data will be written onto the disc momentarily.



This operation may take a while to be completed.

After editing is complete, the title list will appear. e.g.) DVD+RW/DVD-RW

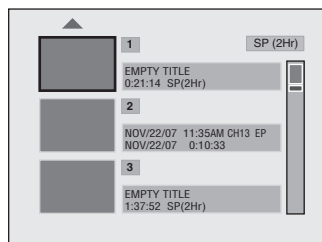

EDITING DISCS

Putting Names on Titles

You can put title names on the titles and change the names from this menu.



1 Follow steps 1 to 3 in “Deleting Titles” on page 63 to display “Edit” menu.

2 Use [▲ / ▼] to select “Edit Title Name”, then press [OK].

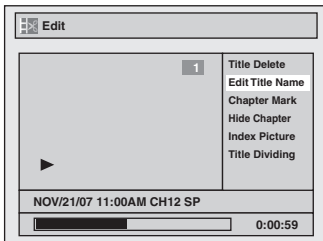

3 To enter a title name, follow the steps of “Guide to Edit Title Name” on this page.

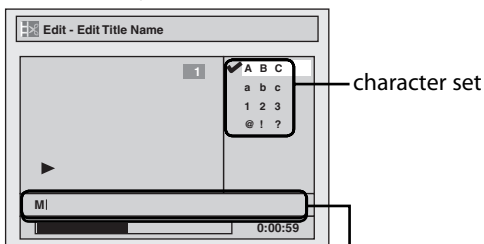

area for entering title names
When you finish entering a title name, press [OK].

4 Use [▲ / ▼] to select “Yes”, then press [OK].

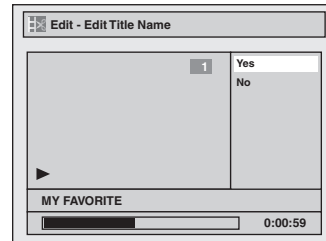

The name you entered will be activated for the title.

5 After this operation is completed, press [RETURN] to exit.
Data will be written onto the disc momentarily.

This operation may take a while to be completed.

Guide to Edit Title Name

- Use [▲ / ▼] to select a desired character set, then press [OK].
- Follow the list below, use [the Number buttons] repeatedly until the desired letter appears.

Select Press	ABC	abc	123	@!?
0	<space>	<space>	0	<space>
1	(*1)	(*1)	1	! " # \$ % & ' () * + , - . / : ; < = > ? @ [] ^ _ { }
2	ABC	abc	2	(*2)
3	DEF	def	3	(*2)
4	GHI	ghi	4	(*2)
5	JKL	jkl	5	(*2)
6	MNO	mno	6	(*2)
7	PQRS	pqrs	7	(*2)
8	TUV	tuv	8	(*2)
9	WXYZ	wxyz	9	(*2)

*1 Press ①, character set will be changed to the “@!?” mode automatically.

*2 Press ② to ⑨, character set will be changed to the previous input mode automatically.

- To delete letters, press [CLEAR] repeatedly. Holding [CLEAR] to delete all letters.
- Use [◀ / ▶] to move the cursor to the left and right.
- You can enter up to 30 letters.

Note

- Undefined letters in a title name are shown by “*”. If you delete them, adjoining letters may change to “**” or other.

EDITING DISCS

Setting Chapter Marks

You can put chapter marks in each title. Once a chapter is marked, you can use it for the chapter search feature.



Note

- When the number of chapter marks in a title is 99 and the number of chapter marks in a disc is 254, chapter marks cannot be added.
- Besides the above-mentioned, it is not likely to be able to add according to recorded time and number of chapters.
- Remaining time of the disc may decrease when adding chapter marks or increase when clearing chapter marks depending on the recording time or edited contents.

1 Follow steps 1 to 3 in “Deleting Titles” on page 63 to display “Edit” menu.

2 Use [▲ / ▼] to select “Chapter Mark”, then press [OK].
Submenu will appear.

3 Press [PLAY ▶] and then [PAUSE ⏸] to decide the point at which you will create a new chapter mark.
• It is convenient to use [◀◀], [▶▶], [◀◀] and [▶▶] for finding the point to add a new chapter mark.

4 Use [▲ / ▼] to select “Add”, then press [OK].

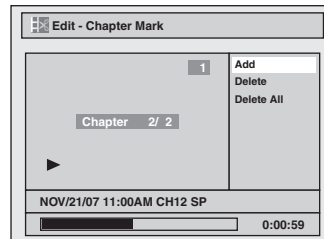

5 Use [▲ / ▼] to select “Yes”, then press [OK].

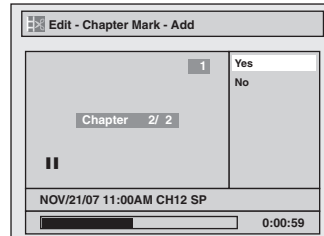

A new chapter mark will be added.

6 Press [RETURN] twice to exit.
Data will be written onto the disc momentarily.

This operation may take a while to be completed.

EDITING DISCS

Clearing Chapter Marks

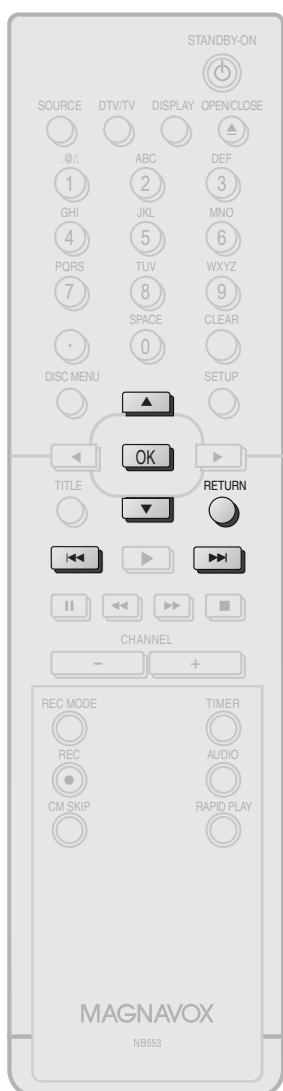

1 Follow steps 1 to 3 in “Deleting Titles” on page 63 to display “Edit” menu.

2 Use [▲ / ▼] to select “Chapter Mark”, then press [OK].
Submenu will appear.

3 Use [◀◀] / [▶▶] to select a chapter mark to be deleted.

4 Use [▲ / ▼] to select “Delete”, then press [OK].

5 Use [▲ / ▼] to select “Yes”, then press [OK].

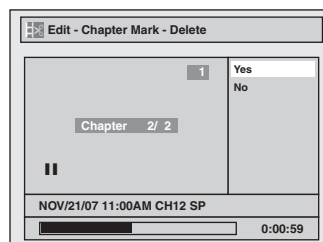

The selected chapter mark will be deleted.

6 Press [RETURN] twice to exit.
Data will be written onto the disc momentarily.

This operation may take a while to be completed.

Note

- Remaining time of the disc may decrease when adding chapter marks or increase when clearing chapter marks depending on the recording time or edited contents.

EDITING DISCS

Clearing Chapter Marks (cont'd)



To delete all chapter marks:

- 1** Follow steps 1 to 3 in “Deleting Titles” on page 63 to display “Edit” menu.
- 2** Use [▲ / ▼] to select “Chapter Mark”, then press [OK].
Submenu will appear.
- 3** Use [▲ / ▼] to select “Delete All”, then press [OK].
- 4** Use [▲ / ▼] to select “Yes”, then press [OK].

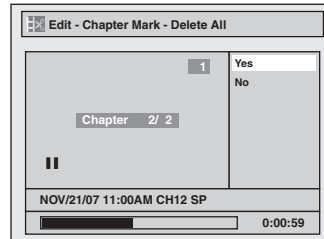

- 5** Use [▲ / ▼] to select “Yes”, then press [OK].

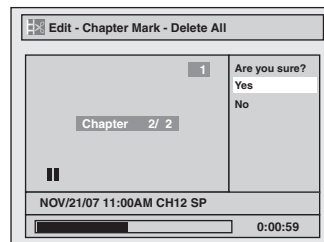

All chapter marks will be deleted.

- 6** Press [RETURN] twice to exit.
Data will be written onto the disc momentarily.

This operation may take a while to be completed.

Note

- Remaining time of the disc may decrease when adding chapter marks or increase when clearing chapter marks depending on the recording time or edited contents.

Introduction

Connections

Basic Setup

Recording

Playback

Editing

Function Setup

Others

Español

EDITING DISCS

Hiding Chapters

You can hide chapters from the title list.
Hidden chapters are skipped during playback.



1 Follow steps 1 to 3 in “Deleting Titles” on page 63 to display “Edit” menu.

2 Use [▲ / ▼] to select “Hide Chapter”, then press [OK].
Submenu will appear.

3 Use [◀◀] / [▶▶] to decide the chapter to be hidden.

4 Use [▲ / ▼] to select “Hidden”, then press [OK].

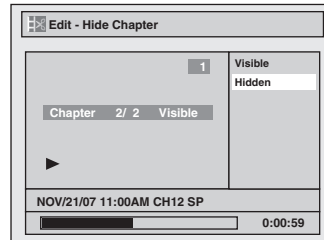

5 After this operation is completed, press [RETURN] twice to exit.
Data will be written onto the disc momentarily.

This operation may take a while to be completed.

If you want hidden chapters to be “Visible”, select the chapter to be shown. Then use [▲ / ▼] to select “Visible” at the step 4 on this page.

Data will be written onto the disc momentarily.
After that, title list is displayed.

Note

- “Hidden” will be displayed in the preview window while previewing the hidden chapter.
- When you make all chapters in the title “Hidden”, “Hidden” is displayed in a thumbnail of the title list.

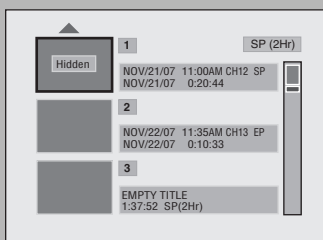

EDITING DISCS

Setting Pictures for Thumbnails

You can set your desired scene as a thumbnail for each title.



1 Follow steps 1 to 3 in “Deleting Titles” on page 63 to display “Edit” menu.

2 Use [◀◀], [▶▶], [◀◀], [▶▶], [PAUSE II] and [PLAY ▶] to decide the picture you want to select as a thumbnail.

3 Use [▲ / ▼] to select “Index Picture”, then press [OK].

4 Use [▲ / ▼] to select “Yes”, then press [OK].

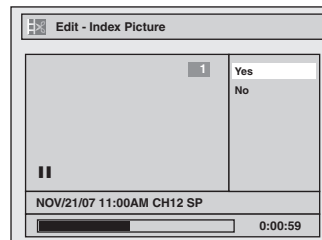

A picture for thumbnail will be set.

5 Press [RETURN] to exit.
Data will be written onto the disc momentarily.

This operation may take a while to be completed.

Note

- If the selected picture for a thumbnail is overwritten, the index picture is reset to the first scene of the title.

Introduction

Connections

Basic Setup

Recording

Playback

Editing

Function Setup

Others

Español

EDITING DISCS

Dividing a Title



You can divide one title into 2 new titles.



1 Follow steps 1 to 3 in “Deleting Titles” on page 63 to display “Edit” menu.

2 Use [◀◀], [▶▶], [◀◀], [▶▶], [PAUSE II] and [PLAY ▶] to decide the point at which you will divide the title.

3 Use [▲ / ▼] to select “Title Dividing”, then press [OK].

4 Use [▲ / ▼] to select “Yes”, then press [OK].

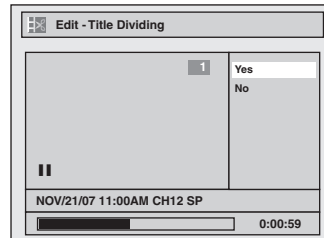

The title will be divided into 2 new titles. Both title names are identical, and index pictures are reset to the first scene at this point.

Data will be written onto the disc momentarily.

This operation may take a while to be completed.

Note

- You cannot divide a title of the disc when the number of recording titles reaches the maximum of 49, and the number of recording chapters reaches the maximum of 254.

EDITING DISCS

Putting Name on Disc

You can put a name on the disc and change it from this menu.



Press [STOP ■] if you are playing back a disc.

- 1 Press [SETUP].
- 2 Use [▲ / ▼] to select "Disc Edit", then press [OK].
- 3 Use [▲ / ▼] to select "Edit Disc Name", then press [OK].
e.g.) DVD+RW

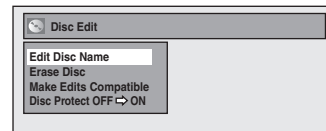

A window for entering a title name will appear.

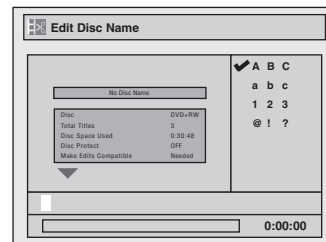

- 4 To enter a disc name, follow the steps of "Guide to Edit Title Name" on page 64.
When you finish entering a title name, press [OK].
- 5 Use [▲ / ▼] to select "Yes", then press [OK].

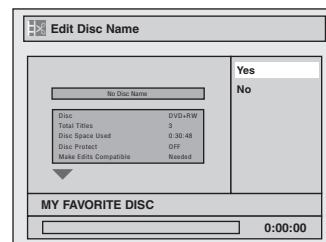

The name you entered will be activated for the title. Data will be written onto the disc momentarily.

This operation may take a while to be completed.

Note

- You cannot select "Disc Edit" when finalized DVD+R or DVD-R is inserted.

Introduction

Connections

Basic Setup

Recording

Playback

Editing

Function Setup

Others

Español

EDITING DISCS

Setting or Releasing Disc Protect

To prevent accidental editing, or erasing the titles, you can protect them.



1 Follow steps 1 to 2 in “Putting Name on Disc” on page 71 to display “Disc Edit” menu.

2 Use [▲ / ▼] to select “Disc Protect OFF → ON”, then press [OK].
e.g.) DVD+RW

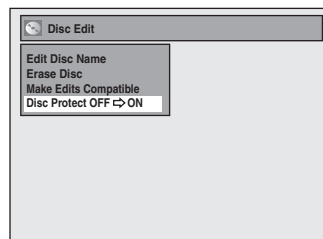

- If the disc is already protected, “Disc Protect ON → OFF” will appear instead of “Disc Protect OFF → ON”.

3 Use [▲ / ▼] to select “Yes”, then press [OK].

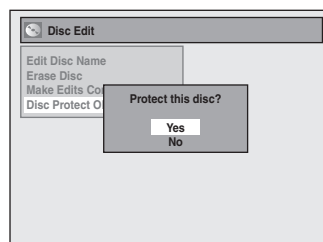

Data will be written onto the disc momentarily.

This operation may take a while to be completed.

EDITING DISCS

Erasing Disc



You can erase all titles on a disc.



Press [STOP ■] if you are playing back a disc.

1 Follow steps 1 to 2 in “Putting Name on Disc” on page 71 to display “Disc Edit” menu.

2 Use [▲ / ▼] to select “Erase Disc”, then press [OK].
e.g.) DVD+RW

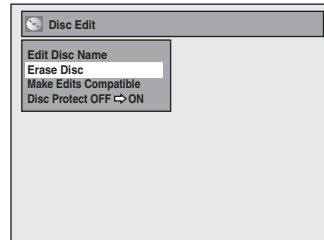

3 Use [▲ / ▼] to select “Yes”, then press [OK].

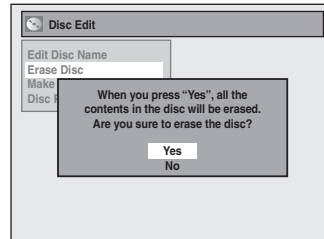

Data will be written onto the disc momentarily.

This operation may take a while to be completed.

Note

- When you select “Yes” at step 3, all contents of the disc will be erased.

Introduction

Connections

Basic Setup

Recording

Playback

Editing

Function Setup

Others

Español

EDITING DISCS

Making Edits Compatible



If you have added or deleted chapters, or made chapters hidden, you must perform "Make Edits Compatible" to see those effects on other unit.



Press [STOP ■] if you are playing back a disc.

1 Follow steps 1 to 2 in "Putting Name on Disc" on page 71 to display "Disc Edit" menu.

2 Use [▲ / ▼] to select "Make Edits Compatible", then press [OK].

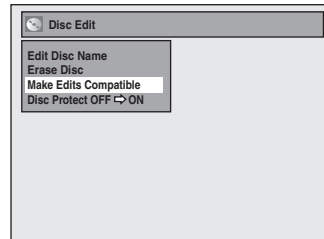

3 Use [▲ / ▼] to select "Yes", then press [OK].

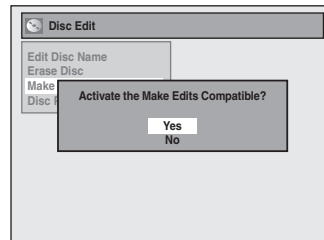

Data will be written onto the disc momentarily.

This operation may take a while to be completed.

LIST OF SETTINGS

The following table is the contents which you can set and the default setting.
Refer to the following table for useful operation.

Setup	Items (highlight is the default)		Contents	
Playback → Pages 77-80	Parental Lock		OFF level 8 [Adult] to 1 [Kid Safe]	Set the parental level for DVD playback.
	Disc Audio	Dynamic Range Control	ON OFF	Compressing the range of sound volume.
		PCM	48kHz 96kHz	Set whether the sound recorded in 96kHz will be down sampled in 48kHz.
		Dolby Digital	PCM Stream	Set the type of sound signal which outputs from the digital audio output jack.
	Disc Menu Language		English French Spanish Other	Set the language for disc menu language.
	Audio Language		Original English French Spanish Other	Set the language for audio.
	Subtitle Language		OFF English French Spanish Other	Set the language for subtitles.
	Angle Icon		ON OFF	Set whether or not to display the angle icon.
	Still Mode		Auto Field Frame	Set the type of still image in pausing playback.
	General Setting Display → Pages 81-82	OSD Language		English Français Español
Screen Saver		OFF 5minutes 10minutes 15minutes 30minutes	Set the idling time before the screen saver starts.	
CC Style → Pages 28-30		DTV CC	OFF Service1 Service2 Service3 Service4 Service5 Service6	Set the type of the DTV closed caption.
		User Setting	ON OFF	Set the whether or not CC style setting is effective.
		Font Size	Middle Large Small	Set font size of the displayed caption.
		Font Style	Style1 Style2 Style3 Style4 Style5 Style6 Style7 Style8	Set font style of the displayed caption.
		Edge Type	None Raised Depressed Uniform L.Shadow R.Shadow	Set edge type of the displayed caption.

Introduction

Connections

Basic Setup

Recording

Playback

Editing

Function Setup

Others

Español

LIST OF SETTINGS

Setup	Items (highlight is the default)		Contents	
Display → Pages 81-82	CC Style → Pages 28-30	Font Opacity	Solid Translucent Flash	Set the font opacity of the displayed caption.
		Font Color	Transparent White Black Red Green Blue Yellow Magenta Cyan	Set the font color of the displayed caption.
		Back Opacity	Solid Translucent Flash	Set back opacity of the displayed caption.
		Back Color	Transparent White Black Red Green Blue Yellow Magenta Cyan	Set back color of the displayed caption.
	V-Chip	Downloadable Rating Change Password	Download rating system via digital broadcasting.	
Video → Pages 83-84	Progressive Scan		ON OFF	Set to the progressive scan mode (set to "ON") or to the interlace scan mode(set to "OFF").
	TV Aspect		4:3 Letter Box 4:3 Pan & Scan 16:9 Wide	Set a picture size according to aspect ratio of your TV.
	Video Input → Page 41	E1(Rear)	Video In S-Video In	Set the video input type for the external input.
		E2(Front)	Video In S-Video In	
Recording	Auto Chapter → Page 32		OFF 5 minutes 10 minutes 15 minutes 30 minutes 60 minutes	Insert chapter marks at even time interval.
	Auto Finalize → Page 45	Disc Full	ON OFF	Set the unit to finalize the disc automatically.
		End of Timer Rec	ON OFF	
	Make Recording Compatible → Page 32		ON OFF	Set to prohibiting additional recording (OFF) or to replace the title list after recording (ON).
Clock → Pages 23-24	Clock Setting		OFF Auto Manual	Set the clock.
	Auto Clock Setting		OFF Auto Manual	Set the clock automatically.
	Daylight Saving Time		ON(MAR-NOV) ON(APR-OCT) OFF	Set the clock for the daylight saving time.
Channel → Pages 20-22	Auto Channel Preset		Antenna Cable (Analog) Cable (Analog/Digital)	Tune the channels automatically.
	Manual Channel Preset			Tune the channels manually.
	TV Audio Select → Page 27		Stereo SAP	Set the analog TV audio type for output and recording.
Reset All → Page 85			Yes No	Set to the default setting.

Note

- Your change to each settings stays on even when the power is off.
- An item which is not currently available is grayed in the settings.

SETUPS

Playback



Press [STOP ■] if you are playing back a disc.

1 Press [SETUP] and use [▲ / ▼] to select "General Setting", then press [OK].

"General Setting" menu will appear.

2 Use [▲ / ▼] to select "Playback", then press [OK].

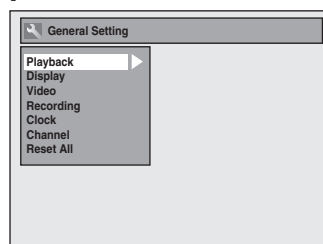

3 Use [▲ / ▼] to select a desired item, then press [OK].

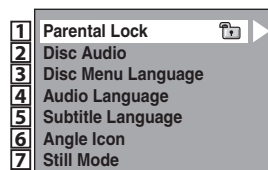

Submenu will appear.

4 Refer to **1** to **7** on pages 78-80 and set the selected item.

5 When you finish with setting, press [SETUP] to exit.

Introduction

Connections

Basic Setup

Recording

Playback

Editing

Function Setup

Others

Español

SETUPS

Playback (cont'd)

1 Parental Lock (Default: OFF)

Some DVD-video feature a parental lock level. Playback will stop if the ratings exceed the levels you set, it will require you to enter a password before the disc will playback. This feature prevents your children from viewing inappropriate material.

Use **[▲ / ▼]** to select the desired level, then press **[OK]**.

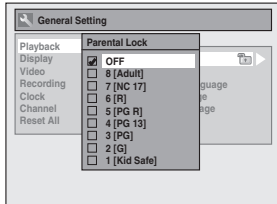

If a password has not been set yet, proceed to **A**.

If a password has been set already, proceed to **B**.

Note

- Parental lock function may not be available to some discs.
- With some DVD, it may be difficult to find if they are compatible with parental lock. Be sure to check if the parental lock function operates in the way that you have set.
- Record the password in case you forget it.
- If there is a DVD in the unit when you set up the parental lock, press **[OPEN/CLOSE ▲]** to activate the parental lock level.

A A password has not been set yet.

Use **[▲ / ▼]** to select "Yes". Use **[the Number buttons]** to enter a new password except for 4737, then press **[OK]**.

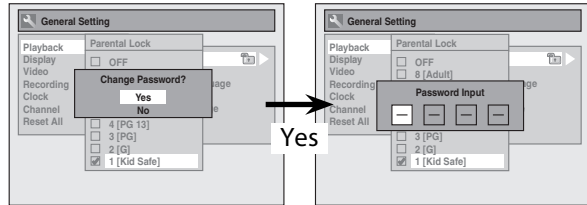

Your setting will be activated.

B A password has been set already.

• Use **[the Number buttons]** to enter the current password.

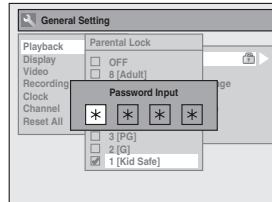

Your setting will be activated.

• If you want to change password, use **[▲ / ▼]** to select "Yes". Use **[the Number buttons]** to enter a new password, then press **[OK]**.

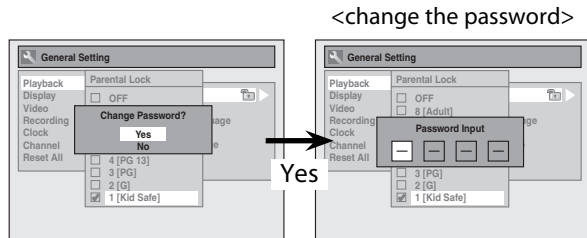

Your setting will be activated.

Note

- Press **[CLEAR]** to erase numbers entered incorrectly.
- When you forget the password or you want to clear all settings in "Parental Lock" menu, enter 4,7,3,7 using **[the Number buttons]** in password input window. Password will be cleared and parental levels will be set to "OFF".

SETUPS

Playback (cont'd)

2 Disc Audio

Choose the appropriate audio setting for your external device.
It will only affect a disc playback.

Use **[▲ / ▼]** to select a desired item, then press **[OK]**.

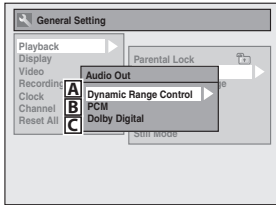

A Dynamic Range Control (Default : ON)

Set to "ON" to compress the range between soft and loud sounds.

Use **[▲ / ▼]** to select a setting, then press **[OK]**.

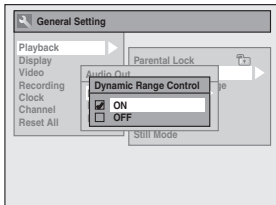

Your setting will be activated.

Note

- Dynamic range control function is available only on the discs which are recorded in the Dolby Digital format.

B PCM (Default : 48kHz)

Use **[▲ / ▼]** to select a setting, then press **[OK]**.

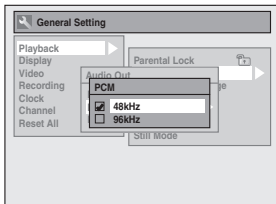

Your setting will be activated.

48kHz : If your amplifier/decoder is NOT compatible with 96kHz PCM, select "48kHz". 96kHz sound will be output in 48kHz.

96kHz : If your amplifier/decoder is compatible with 96kHz PCM, select "96kHz". 96kHz sound will be output.

Note

When playing back disc with copyright protection

- Even if you select "96kHz", the sound will be down sampled at 48kHz.

C Dolby Digital (Default : Stream)

Use **[▲ / ▼]** to select a setting, then press **[OK]**.

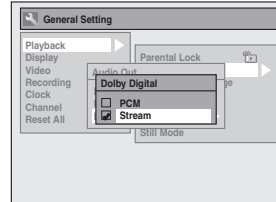

Your setting will be activated.

PCM : Converts the Dolby Digital into PCM (2 channel). When your amplifier/decoder is NOT compatible with Dolby Digital, set to "PCM".

Stream : Outputs Dolby Digital signals When your amplifier/decoder is compatible with Dolby Digital, set to "Stream".

SETUPS

Playback (cont'd)

3 Disc Menu Language (Default : English)

Set the language for disc menu.

Use [▲ / ▼] to select a setting, then press [OK].

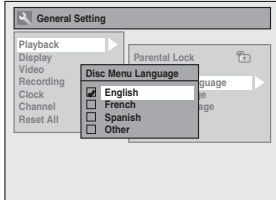

Your setting will be activated.

4 Audio Language (Default : Original)

Set the audio language.

Use [▲ / ▼] to select a setting, then press [OK].

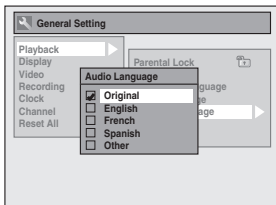

Your setting will be activated.

- When "Original" is selected, the audio language will be in the disc's default language.

5 Subtitle Language (Default : OFF)

Set the subtitle language.

Use [▲ / ▼] to select a setting, then press [OK].

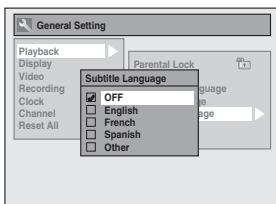

Your setting will be activated.

If "Other" is selected for **3** to **5**, press 4-digit code using [the Number buttons].

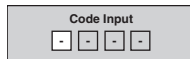

- When you finish entering the code, press [OK]. Refer to the language code table on page 91.

Note

- Only the languages supported by the disc can be selected.
- Audio language setting may not be available to some discs.
- You can change or switch off the subtitles on a DVD also from the disc menu if it is available.
- Press [CLEAR] or [◀] to erase numbers entered incorrectly.

6 Angle Icon (Default : ON)

Set to "ON" to show the angle icon during the playback.

Use [▲ / ▼] to select a setting, then press [OK].

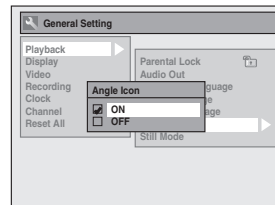

Your setting will be activated.

7 Still Mode (Default : Auto)

Select "Auto" usually.

Use [▲ / ▼] to select a setting, then press [OK].

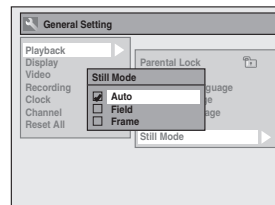

Your setting will be activated.

Auto : Optimum resolution setting ("Field" or "Frame") will be selected.

Field : Images in the still mode will be stabilized.

Frame : Images in the still mode will be highly defined.

Note

- Frame is 1 completed video image made up of 2 fields (There are 30 frames per second of NTSC video).

SETUPS

Display



Press [STOP ■] if you are playing back a disc.

1 Press [SETUP] and use [▲ / ▼] to select "General Setting", then press [OK].

2 Use [▲ / ▼] to select "Display", then press [OK].

3 Use [▲ / ▼] to select a desired item, then press [OK].

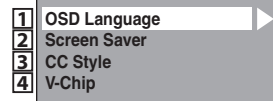

Selection menu will appear.

4 Refer to **1** to **4** on page 82 and set the selected item.

• For **3** refer to pages 28-30.

5 When you finish with setting, press [SETUP] to exit.

Introduction

Connections

Basic Setup

Recording

Playback

Editing

Function Setup

Others

Español

SETUPS

Display (cont'd)

1 OSD Language (Default : English)

Set the language for the on-screen display.

Use [▲ / ▼] to select a setting, then press [OK].

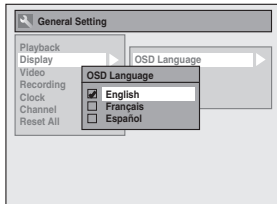

Your setting will be activated.

2 Screen Saver (Default : 10 minutes)

Set the time to activate the screen saver function on the TV screen.

Use [▲ / ▼] to select a setting, then press [OK].

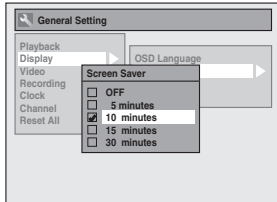

Your setting will be activated.

4 V-Chip

You can set the viewing limitation for the digital TV programs to prevent your children from watching inappropriate programs.

This feature is available only after the digital TV ratings have been downloaded

- The ratings can be downloaded by the unit automatically if it is available in your area.

1) Use [the Number buttons] to enter the access password.

If you have not set the password, first, use [the Number buttons] to set the access password, then press [OK]. The number you entered will be stored as the access password.

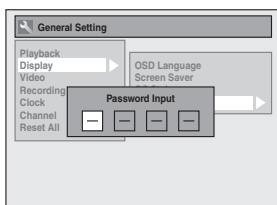

2) Use [▲ / ▼] to select a desired item, then press [OK].

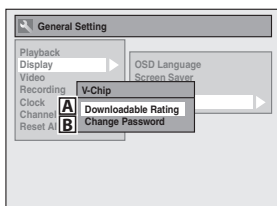

A Downloadable Rating

Set the rating system via digital broadcasting, or clear the downloaded ratings.

If the broadcasting signal does not have the downloadable rating information, the message below will appear.

Downloadable Rating is currently not available.

- This message will also appear when you try to access "DOWNLOADABLE RATING" after you have cleared the downloadable rating information, and the new information has not been downloaded since.

To set the rating:

Use [▲ / ▼] to select "BLOCK SETTING" then press [OK] to show the various types of ratings. Use [▲ / ▼] to select a desired rating to set, then press [OK] to show the levels for the rating. Use [▲ / ▼] to select a level, then press [OK] to switch "VIEW" or "BLOCK". If you set one level to "BLOCK", all the higher levels will be turned to "BLOCK" automatically.

To clear the downloadable rating information and its setting:

Use [▲ / ▼] to select "CLEAR DOWNLOADABLE RATING", then press [OK].

B Change Password

Change the current password.

Use [the Number Buttons] to enter new access password.

Note

- When you forget the access password at step 1), enter 4,7,3,7 using [the Number buttons] in the password input window. Password will be cleared.
- Depending on the type of rating system, you may set the levels individually.

SETUPS

Video

Press [STOP ■] if you are playing back a disc.



1 Press [SETUP] and use [▲ / ▼] to select "General Setting", then press [OK].

2 Use [▲ / ▼] to select "Video", then press [OK].

3 Use [▲ / ▼] to select a desired item, then press [OK].

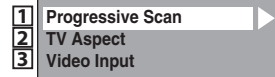

Submenu will appear.

4 Refer to **1** to **2** on page 84 and set the selected item.

• For **3** refer to page 41.

5 When you finish with setting, press [SETUP] to exit.

Introduction

Connections

Basic Setup

Recording

Playback

Editing

Function Setup

Others

Español

SETUPS

Video (cont'd)

1 Progressive Scan (Default : OFF)

This unit is compatible with the progressive scan system. The feature provides you with the higher definition images than the traditional output system does. To utilize this feature, you must set progressive scan mode to "ON".

1) Use [▲ / ▼] to select "ON", then press [OK].

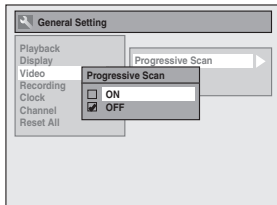

2) Use [◀ / ▶] to select "Yes", then press [OK].

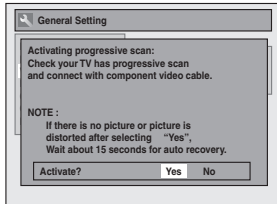

3) Use [▲ / ▼] to select "Yes" within 15 seconds, then press [OK].

Your setting will be activated.

Note

- If your TV is compatible with progressive scan (525p / 480p), you are recommended to use the component video cable (commercially available) to connect this unit to the TV. (Refer to "Method 3" on page 15.) If not, use the RCA video cable and set the progressive scan to "OFF" or press and hold [SETUP] for more than 3 seconds during DVD playback.
- When selecting "No" or not pressing any buttons on the unit or remote control within 15 seconds at step 3, progressive scan remains to be "OFF" (interlace scan).

2 TV Aspect (Default: 4:3 Letter Box)

You can select the TV aspect ratio to match the formats of what you are playing back with the unit and your TV screen (4:3 standard or 16:9 widescreen TV).

Use [▲ / ▼] to select a setting, then press [OK].

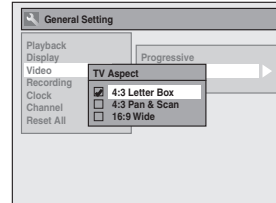

If you have a standard TV:

Select "4:3 Letter Box", so that black bars appear on the top and bottom of the TV screen when playing back a wide-screen picture. Select "4:3 Pan & Scan" for a full height picture with both sides trimmed when playing back wide-screen picture.

If you have a widescreen TV:

Select "16:9 Wide".

SETUPS

Reset All

Reset the setting to default.



1 Press [SETUP] and use [▲ / ▼] to select "General Setting", then press [OK].

"General Setting" menu will appear.

2 Use [▲ / ▼] to select "Reset All", then press [OK].

3 Select "Yes" using [▲ / ▼], then press [OK].

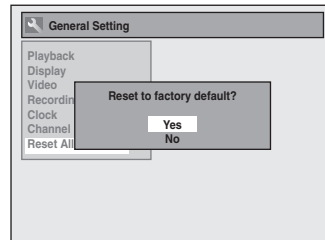

4 Select "Yes" again using [▲ / ▼], then press [OK].

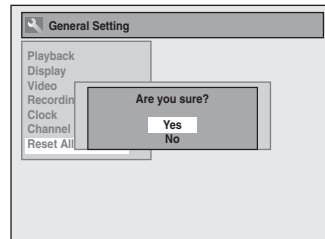

Your setting in recording will be initialized.

Note

- The settings listed below will remain unchanged even after resetting to the factory default.
 - OSD language setting
 - Channel setting
 - Clock setting
 - Parental lock setting
 - V-Chip setting
 - Timer programming information

Introduction

Connections

Basic Setup

Recording

Playback

Editing

Function Setup

Others

Español

TROUBLESHOOTING

Before requesting service for this unit, check the table below for a possible cause of the problem you are experiencing. Some simple checks or a minor adjustment on your part may eliminate the problem and restore proper operation.

Symptom	Remedy
Power	
The power does not turn on.	<ul style="list-style-type: none"> • Check that the AC power cord is connected securely. • Check the breaker (in case of power failure).
Picture	
There is no picture.	<ul style="list-style-type: none"> • Re-connect the connecting cords securely. • Check if the connecting cords are damaged. • If the main menu appears on the TV screen, press [RETURN] to exit. • Check the connection to your TV (page 15). • Check if the progressive scan mode is set correctly according to your TV (page 84). • Switch the input selector on your TV (such as to "E1") so that the signal from the unit appears on the TV screen.
Picture noise appears.	<ul style="list-style-type: none"> • Clean the disc with a cleaning cloth.
Playback picture from the external devices connected to this unit is distorted.	<ul style="list-style-type: none"> • If the picture output signal from the external devices passes through this unit to get to your TV, the copy protection signal applied to some DVD could affect the picture quality. Disconnect the playback device in question and connect it directly to your TV.
TV program reception does not fill the TV screen.	<ul style="list-style-type: none"> • Try to set the channels with "Auto Channel Preset" or "Manual Channel Preset" in "Channel" menu (pages 20-22). • Select a channel of any TV program using [CHANNEL + / -].
TV program pictures are distorted.	<ul style="list-style-type: none"> • Adjust TV antenna. • Adjust the picture. (Refer to the TV's manual.) • Place the unit and TV farther apart. • Place the TV and any bunched RF coaxial cables farther apart.
TV channels cannot be changed.	<ul style="list-style-type: none"> • Switch the input to TV. • Connect the RF coaxial cable correctly (pages 12-14).
Playback picture is distorted.	<ul style="list-style-type: none"> • Keep the device which may cause electrical disturbances, such as a cellular phone, away.
Sound	
There is no sound.	<ul style="list-style-type: none"> • Clean the disc with a cleaning cloth. • Re-connect all connections securely. • Check if the connecting cord is damaged. • Check the connections to the amplifier input. • Check if the input device setting on the amplifier is correct. • When the unit is in pause mode or in slow-motion playback mode, sound is not output. This is not a malfunction. • When the unit is in fast forward or fast reverse mode, sound is not output. This is not a malfunction. • If you are using COAXIAL DIGITAL AUDIO OUTPUT jack, check the setting in "Disc Audio" (page 79).
Sound is noisy.	<ul style="list-style-type: none"> • Clean the disc with a cleaning cloth.
No DTS sound is output.	<ul style="list-style-type: none"> • This unit is not compatible with DTS sound.
Remote control	
The remote control does not function.	<ul style="list-style-type: none"> • Batteries are weak. • There are obstacles between the remote control and the unit. • The remote control is far from the unit. • There are no batteries in the remote control. • Check if the unit is turned on. • Check if you are pointing the remote control at the recorder and NOT the TV. If you have a plasma TV, it may interfere with the IR signal. Try the remote with the plasma off. If the remote works, you may need to move the unit away from the plasma TV.



TROUBLESHOOTING

Symptom	Remedy
Playback The disc does not play back.	<ul style="list-style-type: none"> • No disc is inserted. • A blank disc is inserted. • The disc is upside down. Insert the disc with the labeled side facing up. • The disc is not correctly inserted. • The unit cannot play back certain discs (such as a CD-ROM) (page 46). • The region code on the DVD-video does not match the unit (page 46). • Moisture has condensed inside the unit. Remove the disc and leave the unit turned on for about 2 hours until the moisture evaporates (page 4). • If the disc was recorded on another recorder, the unit cannot play back the disc if it was not finalized.
Discs recorded on this unit cannot be played back on other DVD players.	<ul style="list-style-type: none"> • If you are using DVD+R, DVD-RW/-R disc, please ensure you finalized the disc after recording (page 44).
The disc does not start playback from the beginning.	<ul style="list-style-type: none"> • Resume playback was activated (page 53). Press [STOP ■] twice. • You have inserted a disc whose title menu or DVD menu automatically appears on the TV screen when it is first insert.
The unit starts playing back the disc automatically.	<ul style="list-style-type: none"> • The DVD-video features an auto playback function.
Some functions such as stop, search, or slow-motion playback cannot be performed.	<ul style="list-style-type: none"> • Depending on the disc, you may not be able to do some of the operations. Refer to the manual supplied with the disc.
The language for the sound track cannot be changed.	<ul style="list-style-type: none"> • The title does not have the multilingual audio tracks. • The DVD-video prohibits the changing of the language for the sound track.
The subtitle language cannot be changed or turned off.	<ul style="list-style-type: none"> • Multilingual subtitle are not recorded on the DVD-video.
The angles cannot be changed.	<ul style="list-style-type: none"> • Multi-angles are not recorded on the DVD-video being played back. • The angle-change operation is whenever possible as long as the disc contains a multi-angle portion. Actual change will be performed when the portion has come up. • The DVD-video prohibits changing angles. • Try changing the angle using the DVD-video's menu.
Recording / Timer recording / Editing The channel cannot be changed from the channel you are recording.	<ul style="list-style-type: none"> • Set the TV's input to "TV."
Nothing was recorded even though you set the timer setting correctly.	<ul style="list-style-type: none"> • There was a power failure during recording. • The unit's internal clock stopped due to a power failure that lasted for more than 30 seconds. Reset the clock (pages 23- 24). • The program contains copy protection signals that restricts copying. • The timer setting overlapped with another setting that has priority.
Recording does not stop immediately after you press [STOP ■] .	<ul style="list-style-type: none"> • It may take a few seconds for the unit to input disc data before recording stops.
Timer recording is not complete or did not start from the beginning.	<ul style="list-style-type: none"> • The timer setting overlapped with another setting that has priority (page 38). • Disc space was not enough.

Introduction

Connections

Basic Setup

Recording

Playback

Editing

Function Setup

Others

Español



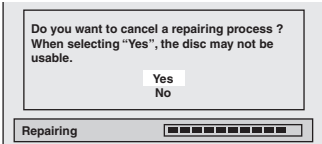

TROUBLESHOOTING

Symptom	Remedy
<p>Others The unit does not operate properly.</p>	<ul style="list-style-type: none"> When static electricity, etc., causes the unit to operate abnormally, unplug the unit and then plug it in again.
<p>The disc tray does not open when you press [OPEN/CLOSE ▲].</p>	<ul style="list-style-type: none"> It may take a few seconds for the disc tray to open after you have recorded or edited a disc. This is because the unit is adding disc data to the disc.
<p>"Repairing" appears on the TV screen.</p> 	<ul style="list-style-type: none"> If there is a power failure or unplugging during recording, finalizing, formatting or editing (even after "Repairing" disappears), a repairing process will begin automatically just after turning the unit on again. It may take several minutes up to about several hours.
<p>In a case you intend to cancel the repairing process.</p> 	<ul style="list-style-type: none"> If you intend to cancel the repairing process, press [OPEN/CLOSE ▲] on the front panel, then select "Yes" and press [OK]. After that, press [OPEN/CLOSE ▲] to take out the disc. The disc canceled during the repairing process MAY NOT work.





TROUBLESHOOTING

Error message	Cause	Solution
Disc Error — Please eject the disc. — Playback feature may not be available on this Disc.	<ul style="list-style-type: none"> Unplayable disc is inserted in the unit. The disc is upside down. 	<ul style="list-style-type: none"> Insert the standardized disc which bear the marks on page 46. Insert the disc with the labeled side facing up.
Region Error — Please eject the disc. — Playback is not authorized in your region.	<ul style="list-style-type: none"> Playback is not authorized in the region of the DVD-video which you inserted in the unit. 	<ul style="list-style-type: none"> Insert the DVD-video with region codes 1 or ALL.
Parental Lock On The current selected parental level prohibits playback.	<ul style="list-style-type: none"> The current selected parental level prohibits playback. 	<ul style="list-style-type: none"> Check “Parental Lock” setting in “Playback” menu (page 78).
Recording Error This program is not allowed to be recorded.	<ul style="list-style-type: none"> The recording function encountered the copy prohibited program. 	<ul style="list-style-type: none"> You cannot record copy prohibited programs.
Recording Error This program is not recordable in +VR mode.	<ul style="list-style-type: none"> You are trying to record the copy-once program. 	<ul style="list-style-type: none"> You cannot record the copy-once program.
Recording Error Can not record on this disc.	<ul style="list-style-type: none"> You are trying to record onto the disc which is unrecordable, or the disc status is unable to record. The disc is dirty. The disc is damaged. 	<ul style="list-style-type: none"> Insert the recordable disc, and ensure the disc status satisfies the recording requirements (page 31). Clean the disc with a cleaning cloth. Replace the disc.
Recording Error This disc is protected and not recordable.	<ul style="list-style-type: none"> You are trying to record on to the protected disc which is set in “Disc Edit” menu. 	<ul style="list-style-type: none"> Release the disc protect setting in “Disc Edit” menu (page 72).
Recording Error Disc is full. (No area for new recording)	<ul style="list-style-type: none"> You are trying to record onto the disc which has no space for recording. 	<ul style="list-style-type: none"> Insert the recordable disc with enough recording space.
Recording Error You cannot record more than 49 titles on one disc. (The maximum is 49)	<ul style="list-style-type: none"> You are trying to record onto the disc on which the number of recording titles comes up to the maximum (49). 	<ul style="list-style-type: none"> Delete unnecessary titles (page 63).
Recording Error You cannot record more than 254 chapters on one disc. (The maximum is 254)	<ul style="list-style-type: none"> You are trying to record onto the DVD+RW or DVD-RW on which the number of recording chapters comes up to the maximum (254). 	<ul style="list-style-type: none"> Delete unnecessary chapter marks (pages 66-67).
Recording Error You cannot record on this disc as Power Calibration Area is full.	<ul style="list-style-type: none"> When recordings are performed repeatedly onto an unstable disc, this area may come up to be full. Every time you insert a disc for recording, the disc’s working area will be taken up. And if you repeat this frequently, it will be used up sooner and you may not be able to record full 49 titles. 	<ul style="list-style-type: none"> Insert a new disc.
Recording Error This disc is already finalized.	<ul style="list-style-type: none"> You are trying to record onto the disc already finalized. 	<ul style="list-style-type: none"> Release the finalizing for this disc (page 44).
Recording Error The disc has no recording compatibility. Set “Make Recording Compatible” to “ON” to convert the disc.	<ul style="list-style-type: none"> You are trying to record onto the disc that had been recorded by other recorders. 	<ul style="list-style-type: none"> Set “Make Recording Compatible” to “ON” to rewrite the menu, after that you will record to disc (page 32).

* If you are still having trouble with the unit after checking “TROUBLESHOOTING”, write down the error code and the error description for calling our help line mentioned on the front page to locate an Authorized Service Center.

Introduction

Connections

Basic Setup

Recording

Playback

Editing

Function Setup

Others

Español





TROUBLESHOOTING

Frequently Asked Questions

- | | |
|---|--|
| - Can I record to CD-RW/-R? | No, this unit records only DVD. |
| - Can I play back DVD-video that is bought in another country? | Possible when the region code of the disc is 1 and All. |
| - Can I connect the unit to my PC? | No, you cannot control the unit by PC. |
| - Can I program a timer recording with cable/satellite box? | Yes, you can. Select "E1" or "E2" as your recording channel, and leave the cable/satellite box on (pages 14, 35-38). |
| - Can I record one channel while watching another channel using a cable / satellite box? | It depends on your connection configurations. For more details, please kindly contact your cable / satellite provider. |
| - Can I connect this unit directly to a TV which only has an antenna in jack using an RF coaxial cable? | No. You need an RF modulator (commercially available) to connect this unit to a TV which only has an antenna in jack (page 13). This unit does not have an RF modulator. |
| - Can I change the channels on the cable / satellite box using the remote control of this unit? | No. Changing the channels on the cable / satellite box using this unit's remote control is not possible. You need to use the remote control supplied with the cable / satellite box to change the channels on the cable / satellite box. |



LANGUAGE CODE

Language	Code
Abkhazian	4748
Afar	4747
Afrikaans	4752
Albanian	6563
Amharic	4759
Arabic	4764
Armenian	5471
Assamese	4765
Aymara	4771
Azerbaijani	4772
Bashkir	4847
Basque	5167
Bengali;Bangla	4860
Bhutani	5072
Bihari	4854
Bislama	4855
Breton	4864
Bulgarian	4853
Burmese	5971
Byelorussian	4851
Cambodian	5759
Catalan	4947
Chinese	7254
Corsican	4961
Croatian	5464
Czech	4965
Danish	5047
Dutch	6058
English	5160
Esperanto	5161
Estonian	5166
Faroese	5261
Fiji	5256
Finnish	5255
French	5264
Frisian	5271
Galician	5358
Georgian	5747
German	5051
Greek	5158
Greenlandic	5758
Guarani	5360
Gujarati	5367
Hausa	5447
Hebrew	5569
Hindi	5455

Language	Code
Hungarian	5467
Icelandic	5565
Indonesian	5560
Interlingua	5547
Interlingue	5551
Inupiak	5557
Irish	5347
Italian	5566
Japanese	5647
Javanese	5669
Kannada	5760
Kashmiri	5765
Kazakh	5757
Kinyarwanda	6469
Kirghiz	5771
Kirundi	6460
Korean	5761
Kurdish	5767
Laothian	5861
Latin	5847
Latvian; Lettish	5868
Lingala	5860
Lithuanian	5866
Macedonian	5957
Malagasy	5953
Malay	5965
Malayalam	5958
Maltese	5966
Maori	5955
Marathi	5964
Moldavian	5961
Mongolian	5960
Nauru	6047
Nepali	6051
Norwegian	6061
Occitan	6149
Oriya	6164
Oromo (Afan)	6159
Panjabi	6247
Pashto; Pushto	6265
Persian	5247
Polish	6258
Portuguese	6266
Quechua	6367
Rhaeto-Romance	6459
Romanian	6461

Language	Code
Russian	6467
Samoan	6559
Sangho	6553
Sanskrit	6547
Scots Gaelic	5350
Serbian	6564
Serbo-Croatian	6554
Sesotho	6566
Setswana	6660
Shona	6560
Sindhi	6550
Singhalese	6555
Siswat	6565
Slovak	6557
Slovenian	6558
Somali	6561
Spanish	5165
Sundanese	6567
Swahili	6569
Swedish	6568
Tagalog	6658
Tajik	6653
Tamil	6647
Tatar	6666
Telugu	6651
Thai	6654
Tibetan	4861
Tigrinya	6655
Tonga	6661
Tsonga	6665
Turkish	6664
Turkmen	6657
Twi	6669
Ukrainian	6757
Urdu	6764
Uzbek	6772
Vietnamese	6855
Volapuk	6861
Welsh	4971
Wolof	6961
Xhosa	7054
Yiddish	5655
Yoruba	7161
Zulu	7267

Introduction

Connections

Basic Setup

Recording

Playback

Editing

Function Setup

Others

Español

GLOSSARY

Analog Audio

An electrical signal that directly represents sound. Compare this to digital audio which can be an electrical signal, but is an indirect representation of sound. See also "Digital Audio".

Aspect Ratio

The width of a TV screen relative to its height. Conventional TVs are 4:3 (in other words, the TV screen is almost square); widescreen models are 16:9 (the TV screen is almost twice as wide as it is high).

Chapter

Just as a book is split up into several chapters, a title on a DVD is usually divided into chapters. See also "Title".

Component Video Output

Each signal of luminance (Y) and component (P_B/C_B, P_R/C_R) is independent to output so that you can experience picture color as it is.

Also, due to compatibility with progressive video (525p/480p), you can experience higher-density picture than that in interlace (525i/480i).

Digital Audio

An indirect representation of sound by numbers. During recording, the sound is measured at discrete intervals (44,100 times a second for CD audio) by an analog-to-digital converter, generating a stream of numbers. On playback, a digital-to-analog converter generates an analog signal based on these numbers. See also "Sampling Frequency" and "Analog Audio".

Dolby Digital

The system to compress digital sound developed by Dolby Laboratories. It offers you sound of stereo(2ch) or multi channel audio.

Finalize

To make DVD, which have been recorded on, possible to play back in DVD players. With this unit, it is possible to finalize DVD+R, DVD-RW, and DVD-R.

MP3 (MPEG audio layer 3)

MP3 is a method of compressing files. You can copy MP3 files on CD-RW/-R from the computer and play back the files on this unit.

PBC (playback control) (video CD only)

This function enables you to play back interactive software using a menu screen. See also "Video CD".

PCM (pulse code modulation)

The most common system of encoding digital audio, found on CD and DAT. Excellent quality, but requires a lot of data compared to formats such as Dolby Digital and MPEG audio. For compatibility with digital audio recorders (CD, MD and DAT) and AV amplifiers with digital inputs, this unit can convert Dolby Digital and MPEG audio to PCM. See also "Digital Audio".

Progressive Scan (525p/480p)

A type of display that does not split each frame into fields, and instead scans directly through all the scanlines of each frame in order. Progressive scan provides less flickering and higher image resolution than traditional (525i/480i) TV signals. Refer to page 84 for instructions on selective progressive scan mode.

Region Code

Regions associate discs and players with particular areas of the world. This unit will only play back discs that have compatible region codes. You can find the region code of your unit by looking on the rear panel. Some discs are compatible with more than one region (or all regions).

Sampling Frequency

The rate which sound is measured by a specified interval to turn into digital audio data. The numbers of sampling in one second defines as sampling frequency. The higher the rate, the better the sound quality.

SAP (secondary audio program)

Sub-audio channel which is delivered separately from main-audio channel. This audio channel is used as an alternate in bilingual broadcasting.

S-Video Output

It delivers independently each signal of color(C) and luminance(Y) to TV as video signals, so that higher-quality picture will be gained.

Title (DVD only)

A collection of chapters on DVD. See also "Chapter".

Track

Audio CD use tracks to divide up the content of a disc. The DVD equivalent is called a chapter. See also "Chapter".

Video CD

A digital format for store video data in compact disc.

SPECIFICATIONS

General

System	DVD+RW/+R, DVD-RW/-R, DVD-video, CD-DA, Video CD, CD-RW/-R
Power requirements	120V AC +/-10%, 60Hz +/-5%
Power consumption	22W (standby: 2.0W)
Dimensions (width x height x depth)	16 ⁹ / ₁₆ x 2 ³ / ₈ x 9 ³ / ₄ inches (420 x 59 x 247mm)
Weight	4.7 lbs. (2.1kg)
Operating temperature	41°F (5°C) to 104°F (40°C)
Operating humidity	Less than 80% (no condensation)
TV format	ATSC / NTSC-M TV standard

Recording

Recording format	+VR (video recording) format
Recording discs	DVD+Rewritable, DVD+Recordable DVD-Rewritable, DVD-Recordable (+VR mode only)

Video recording format

Sampling frequency	13.5 MHz
Compression format	MPEG

Audio recording format

Sampling frequency	48 kHz
Compression format	Dolby Digital

Tuner

Tuning system	Channel frequency synthesized tuning system
---------------	---

Channel coverage (ATSC / NTSC)

Terrestrial	VHF 2~13, UHF 14~69
CATV	2~13, A~W, W+1~W+94 (analog W+1~W+84), A-5~A1, 5A

Terminals

	Audio input	Video input	S-video input	VHF/UHF/CATV input and output	Audio input	Audio output	Video input	Video output	S-video input	S-video output	Component video output	Coaxial digital audio output
Front	RCA jack x 2			F-type	RCA jack x 2	RCA jack x 2	RCA jack x 1	RCA jack x 1	Mini DIN 4-pin x 1	Mini DIN 4-pin x 1	RCA jack x 3	RCA jack x 1
		2V rms (input impedance: more than 22kΩ)	1Vp-p (75Ω)	75Ω unbalanced		2V rms (output impedance: more than 1kΩ)	1Vp-p (75Ω)	1Vp-p (75Ω)	Y: 1Vp-p (75Ω) C: 286mVp-p (75Ω)	Y: 1Vp-p (75Ω) C: 286mVp-p (75Ω)	Y: 1Vp-p (75Ω) PB/CB: 700mVp-p (75Ω) PR/CR: 700mVp-p (75Ω)	500mVp-p (75Ω)
Rear												

Note

- The specifications and design of this product are subject to change without notice.

Introduction

Connections

Basic Setup

Recording

Playback

Editing

Function Setup

Others

Español

ESPAÑOL

Discos Reproducibles

Este aparato es compatible con la reproducción de los siguientes discos y archivos.

Discos reproducibles	Logotipos
DVD-video	
DVD+RW	
DVD+R	
DVD-RW (Sólo discos en modo de video finalizados)	
DVD-R (Sólo discos en modo de video finalizados)	
CD-DA (CD de audio)	
CD de video	
CD-RW	
CD-R	
Archivos reproducibles	Medio
CD-DA	CD-RW/-R
MP3	

es una marca registrada de DVD Format/Logo Licensing Corporation.

Códigos de Región

El número presente en el interior del globo se refiere a una región del mundo. Este aparato puede reproducir discos DVD que estén rotulados para ALL las regiones o para la región 1.



Disco Grabable

Este aparato puede grabar a DVD+RW, DVD+R, DVD-RW y DVD-R.

Los discos DVD+R/DVD-R pueden ser grabados sólo una vez. Los discos DVD+RW/DVD-RW pueden ser grabados y borrados muchas veces.

En este aparato los discos DVD-RW/-R serán grabados automáticamente en el modo DVD+VR.

• Los siguientes discos se recomiendan para obtener una buena calidad de grabación y han sido comprobados como compatibles con este aparato. Sin embargo, según sea la condición del medio el equipo podría no leer el disco correctamente.

Verbatim	DVD+R 8x/16x, DVD-R 8x, DVD-RW 4x	DVD+RW 4x, DVD-RW 2x
JVC	DVD+R 4x/8x/16x,	DVD-R 8x/16x
Maxell	DVD+R 4x/8x/16x,	DVD+RW 4x
SONY	DVD+R 4x/8x/16x,	DVD+RW 4x
TDK	DVD+R 4x/8x/16x	

El comportamiento de cualquier otro disco no está garantizado.

• **Usted puede reproducir discos DVD+RW en la mayoría de los reproductores de DVD sin finalizarlos. Sin embargo, si usted ha añadido o eliminado capítulos, u ocultado capítulos, debe ejecutar "Compatibilizar edic." antes de poder ver dichos efectos en otros equipos. (Consulte la página 74.) Para reproducir discos que no sean DVD+RW en otros reproductores de DVD, usted necesitará finalizarlos.**

Logotipo	Atributos
	Disco de 8 cm / 12 cm, un solo lado, una sola capa Tiempo de grabación máx. aprox. (modo SLP): 360 minutos (4,7 GB) (para 12 cm) 108 minutos (1,4 GB) (para 8 cm)

Disco no Grabable

- Un DVD-RW grabado en un modo distinto de +VR no será grabable en este aparato a menos que usted borre todo el contenido del disco. (Consulte la página 73.)
- Un DVD-R grabado en un modo distinto de +VR no será grabable en este aparato.

Conexión Básica

- 1) Desconecte el cable de alimentación de su televisor del tomacorriente de CA.
- 2) Efectúe la conexión básica ilustrada más abajo.

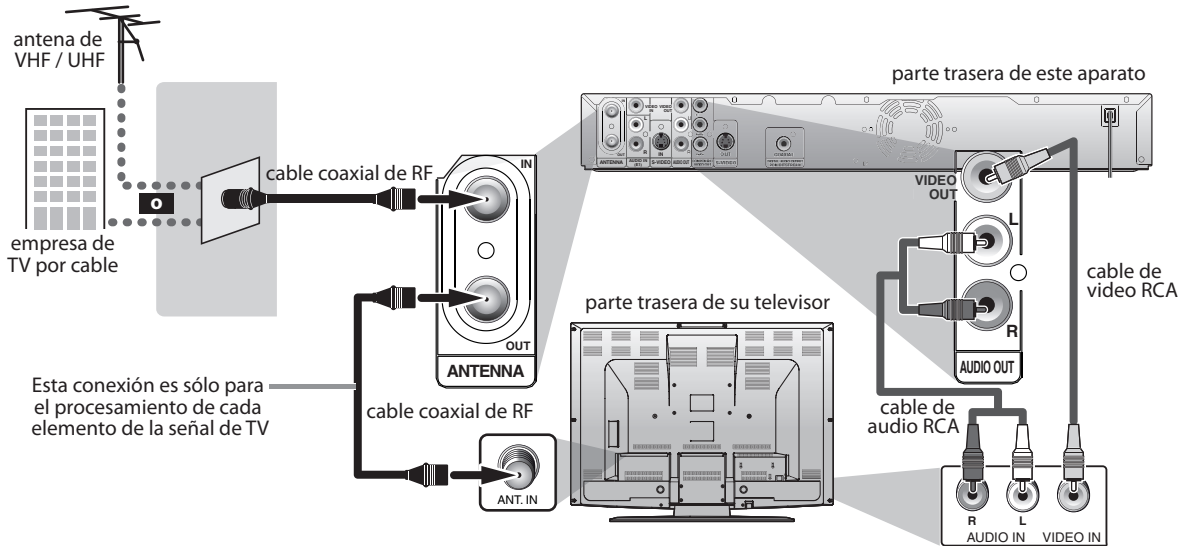

- 3) Enchufe los cables de alimentación de los aparatos al tomacorriente de CA.

Conexión a Una Caja de TV por Cable / Satelital

- 1) Desconecte el cable de alimentación de su televisor del tomacorriente de CA.
- 2) Efectúe la conexión como se ilustra abajo.

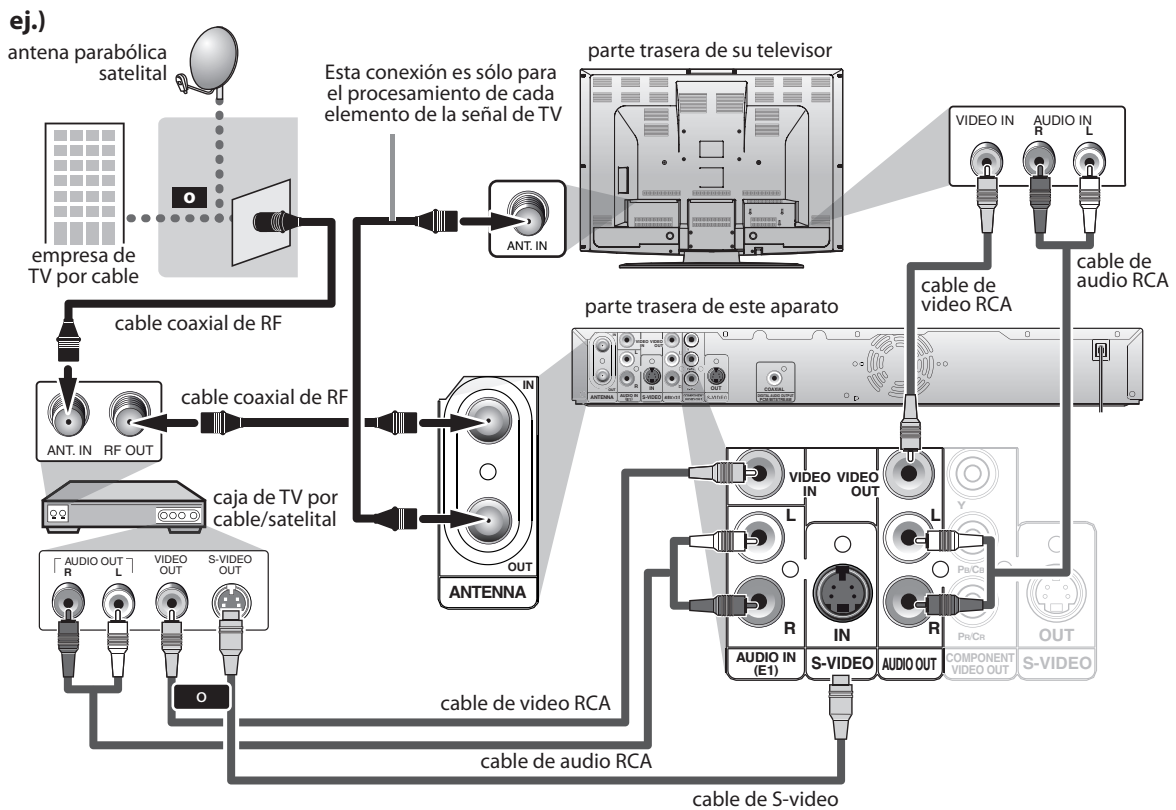



- 3) Enchufe los cables de alimentación de los aparatos al tomacorriente de CA.



Configuración Inicial

Cuando usted encienda este aparato por primera vez necesita seguir estos pasos.

- 1** Presione [STANDBY-ON ].
Encienda el televisor. Seleccione la entrada a la cual está conectado el aparato.

- 2** Utilice [ / ] para seleccionar su idioma deseado, y luego presione [OK] para establecerlo.





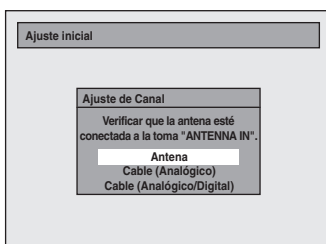

- 3** Utilice [ / ] para seleccionar el tipo de señal de emisión, y luego presione [OK].

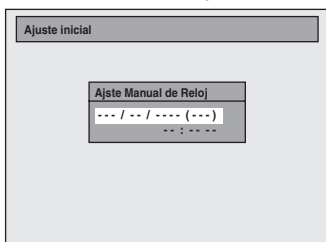

El equipo comenzará a obtener los canales disponibles en su región.

- 4** Presione [OK] para activar "Ajuste Manual de Reloj".



- 5** Utilice [ / ] para seleccionar un elemento a configurar, y utilice [ / ] para seleccionar el contenido de su preferencia, y luego presione [OK].



Grabación Básica

- 1** Presione [OPEN/CLOSE ] para abrir la bandeja de discos e insertar su disco con el rótulo apuntando hacia arriba.

* Asegúrese de que el disco sea compatible con este aparato. (Para obtener la lista de discos compatibles consulte la página 31.)

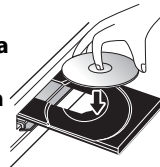

- 2** Para seleccionar un modo de grabación presione [REC MODE].

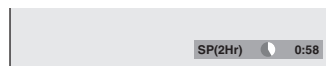

Modo de grabación	Tiempo de grabación		Calidad del video y el sonido
	Disco de 8 cm	Disco de 12 cm	
HQ (1Hr)	18 min	60 min	Buena ↑ ↓ Deficiente
SP (2Hr)	36 min	120 min	
SPP (2.5Hr)	45 min	150 min	
LP (3Hr)	54 min	180 min	
EP (4Hr)	72 min	240 min	
SLP (6Hr)	108 min	360 min	

- 3** Presione [DTV/TV] para seleccionar TV analógica o TV digital, luego y utilice [CHANNEL + / -] o [los botones numéricos] para seleccionar un canal que se desee grabar.



- 4** Presione [REC ] para iniciar la grabación.

Para configurar la grabación a un toque con temporizador (OTR)...

Esta es una manera sencilla de configurar el tiempo de grabación en bloques de 30 minutos.

Presione [REC ] repetidamente hasta que aparezca en la pantalla del televisor la longitud deseada de grabación (30 minutos a 6 horas).

Comenzará la grabación a un toque con temporizador.

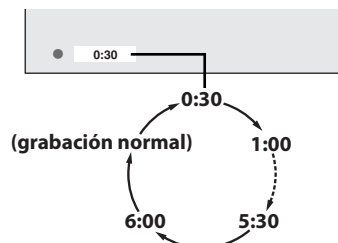

• Para cancelar la grabación a un toque con temporizador dentro del tiempo especificado, presione [STOP ].

- 5** Para de tener la grabación presione [STOP ].

Grabación con Temporizador

Usted puede programar el equipo para que grabe hasta 12 programas, con un mes de anticipación. También hay disponibles grabaciones de programas diarias o semanales.

Antes de grabar, asegúrese de que

- Antes de establecer una programación del temporizador configure el reloj.
- Inserte un disco grabable con suficiente espacio libre.

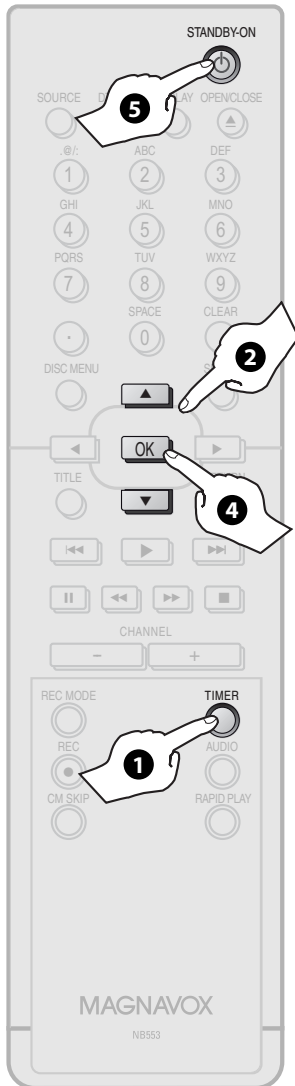

1 Presione [TIMER].

2 Utilice [▲ / ▼] para seleccionar "Prog. nuevo", y luego presione [OK].

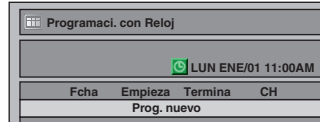

3 Configure una programación del temporizador.

4 Presione [OK].

5 Presione [STANDBY-ON] para configurar una programación del temporizador.

El indicador TIMER REC del panel frontal se iluminará.

Configure la fecha.



Configure las horas de inicio y finalización.



Seleccione un modo deseado de entrada y el canal a grabar.

Para obtener más detalles, consulte "How to select a channel number for the timer recording" en la página 37 del manual del usuario.

ej.) modo digital



Seleccione un modo de grabación.



Reproducción

1 Abra la bandeja de discos.

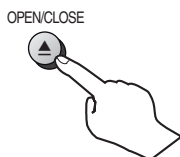

2 Inserte un disco.

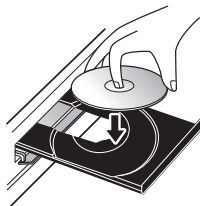

3 Comience a reproducir.

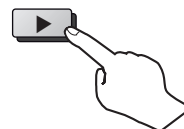

4 Detenga la reproducción.

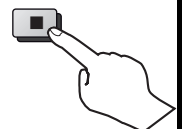



MEMO





MEMO





MAGNAVOX

LIMITED WARRANTY

FUNAI CORP. will repair this product, free of charge in the USA in the event of defect in materials or workmanship as follows:

DURATION:

PARTS: FUNAI CORP. will provide parts to replace defective parts without charge for one (1) year from the date of original retail purchase. Certain parts are excluded from this warranty.

LABOR: FUNAI CORP. will provide the labor without charge for a period of ninety (90) days from the date of original retail purchase.

LIMITS AND EXCLUSIONS:

THIS WARRANTY IS EXTENDED ONLY TO THE ORIGINAL RETAIL PURCHASER. A PURCHASE RECEIPT OR OTHER PROOF OF ORIGINAL RETAIL PURCHASE WILL BE REQUIRED TOGETHER WITH THE PRODUCT TO OBTAIN SERVICE UNDER THIS WARRANTY.

This warranty shall not be extended to any other person or transferee.

This warranty is void and of no effect if any serial numbers on the product are altered, replaced, defaced, missing or if service was attempted by an unauthorized service center. This limited warranty does not apply to any product not purchased and used in the United States.

This warranty only covers failures due to defects in material or workmanship which occur during normal use. It does not cover damage which occurs in shipment, or failures which are caused by repairs, alterations or products not supplied by FUNAI CORP., or damage, which results from accident, misuse, abuse, mishandling, misapplication, alteration, faulty installation, improper maintenance, commercial use such as hotel, rental or office use of this product, or damage which results from fire, flood, lightning or other acts of God.

THIS WARRANTY DOES NOT COVER PACKING MATERIALS, ANY ACCESSORIES (EXCEPT REMOTE CONTROL), ANY COSMETIC PARTS, COMPLETE ASSEMBLY PARTS, DEMO OR FLOOR MODELS.

FUNAI CORP. AND ITS REPRESENTATIVES OR AGENTS SHALL IN NO EVENT BE LIABLE FOR ANY GENERAL, INDIRECT OR CONSEQUENTIAL DAMAGES ARISING OUT OF OR OCCASIONED BY THE USE OF OR THE INABILITY TO USE THIS PRODUCT. THIS WARRANTY IS MADE IN LIEU OF ALL OTHER WARRANTIES, EXPRESS OR IMPLIED, AND OF ALL OTHER LIABILITIES ON THE PART OF FUNAI, ALL OTHER WARRANTIES INCLUDING THE WARRANTY OF MERCHANTABILITY AND FITNESS FOR A PARTICULAR PURPOSE, ARE HEREBY DISCLAIMED BY FUNAI AND ITS REPRESENTATIVES IN THE UNITED STATES.

ALL WARRANTY INSPECTIONS AND REPAIRS MUST BE PERFORMED BY AN AUTHORIZED SERVICE CENTER.

THIS WARRANTY IS ONLY VALID WHEN THE UNIT IS CARRIED-IN TO AN AUTHORIZED SERVICE CENTER.

THE PRODUCT MUST BE ACCOMPANIED BY A COPY OF THE ORIGINAL RETAIL PURCHASE RECEIPT. IF NO PROOF OF PURCHASE IS ATTACHED, THE WARRANTY WILL NOT BE HONORED AND REPAIR COSTS WILL BE CHARGED.

IMPORTANT:

THIS LIMITED WARRANTY GIVES YOU SPECIFIC LEGAL RIGHTS. YOU MAY HAVE OTHER RIGHTS THAT VARY FROM STATE TO STATE. IF, AT ANY TIME DURING THE WARRANTY PERIOD, YOU ARE UNABLE TO OBTAIN SATISFACTION WITH THE REPAIR OF THIS PRODUCT, PLEASE CONTACT FUNAI CORP.

ATTENTION:

FUNAI CORP. RESERVES THE RIGHT TO MODIFY ANY DESIGN OF THIS PRODUCT WITHOUT PRIOR NOTICE.

WARRANTY STATEMENT REGARDING NON AUTHORIZED REPAIRS:

To obtain warranty service, you must take the product, or deliver the product freight prepaid, in either its original packaging or packaging affording an equal degree of protection, to any AUTHORIZED SERVICE CENTER. FUNAI CORP. will not reimburse you for any service done by unauthorized service providers without prior written approval.

To locate your nearest AUTHORIZED SERVICE CENTER or for general service inquiries, please contact us at:

FUNAI CORPORATION

Customer Service

Tel: 1-800-605-8610

<http://www.funai-corp.com>

19900 Van Ness Avenue, Torrance, CA 90501



Quick Guide

DIGITAL VIDEO DISC RECORDER ZC350MS8

Playable Discs

This unit is compatible to play back the following discs / files.

Playable discs	Logos	Playable discs	Logos
DVD-video		CD-DA (audio CD)	
DVD+RW		video CD	
DVD+R		CD-RW	
DVD-RW		CD-R	
DVD-R (Finalized video mode discs only)		CD-DA	
DVD-R (Finalized video mode discs only)		MP3	
		Media	
		CD-RW/-R	

is a trademark of DVD Format/Logo Licensing Corporation.

Region Codes

The number inside the globe refers to region of the world. This unit can playback DVD that are labeled for ALL regions or for Region 1.



Recordable Discs

This unit can record to DVD+RW, DVD+R, DVD-RW and DVD-R. DVD+R/DVD-R can only be recorded to once. DVD+RW/DVD-RW can be recorded to and erased many times. **DVD-RW/-R will be recorded in the DVD+VR mode automatically in this unit.**

Following discs are recommended for good recording quality and are proven to be compatible with this unit. However, depending on the media condition the unit may not read the disc properly.

Verbatim DVD+R 8x/16x, DVD+RW 4x, DVD-R 8x, DVD-RW 2x
 JVC DVD-RW 4x
 Maxell DVD+R 4x/8x/16x, DVD-R 8x/16x
 SONY DVD+R 4x/8x/16x, DVD+RW 4x
 TDK DVD+R 4x/8x/16x

Performance of any other discs are not guaranteed.

You can play back DVD+RW on most DVD players without finalizing. However, if you have added or deleted chapters, or made chapters hidden, you must perform "Make Edits Compatible" before being able to see those effects on other units. (Refer to page 74 in the owner's manual.) To play back discs other than DVD+RW on other DVD players, you will need to finalize.

Unrecordable Discs

- DVD-RW recorded in the mode other than +VR is not recordable on this unit unless you erase all contents in the disc. (Refer to page 73 in the owner's manual.)
- DVD-R recorded in the mode other than +VR is not recordable on this unit.

Logo

Logo	Attributes
	8cm/12cm, single-sided, single layer disc
	Approx. max. recording time (SLP mode):
	360 minutes (4.7GB) (for 12cm)
	108 minutes (1.4GB) (for 8cm)

1 Connections

Basic Connection

- 1) Disconnect the power cord of your TV from the AC outlet.
- 2) Make the basic connection as illustrated below.

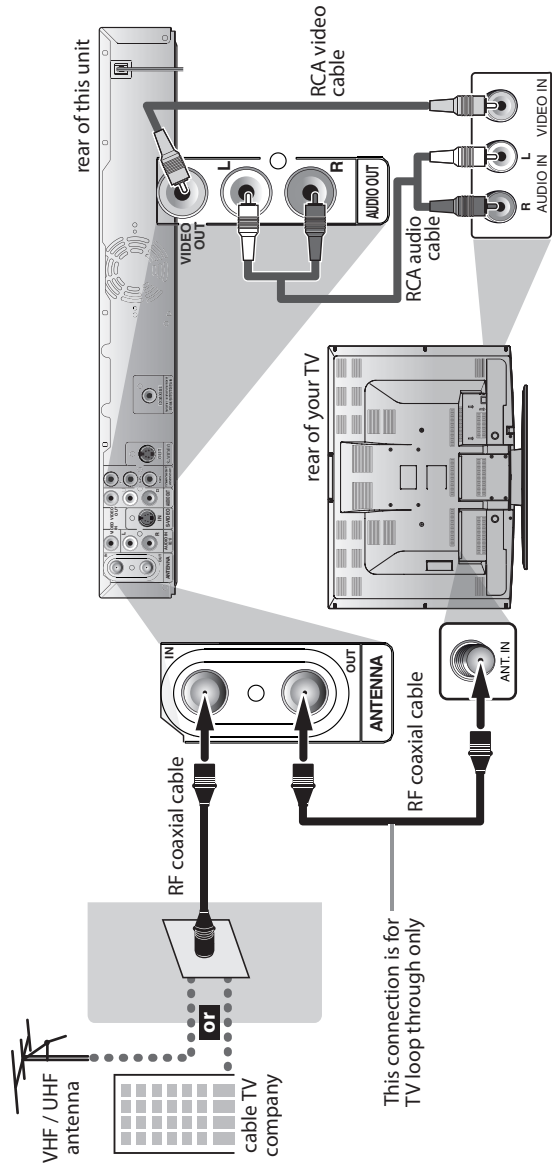

- 3) Plug in the power cords of the devices to the AC outlet.

Connection to a Cable / Satellite Box

- 1) Disconnect the power cords of the devices from the AC outlet.
- 2) Make the connection as illustrated below.

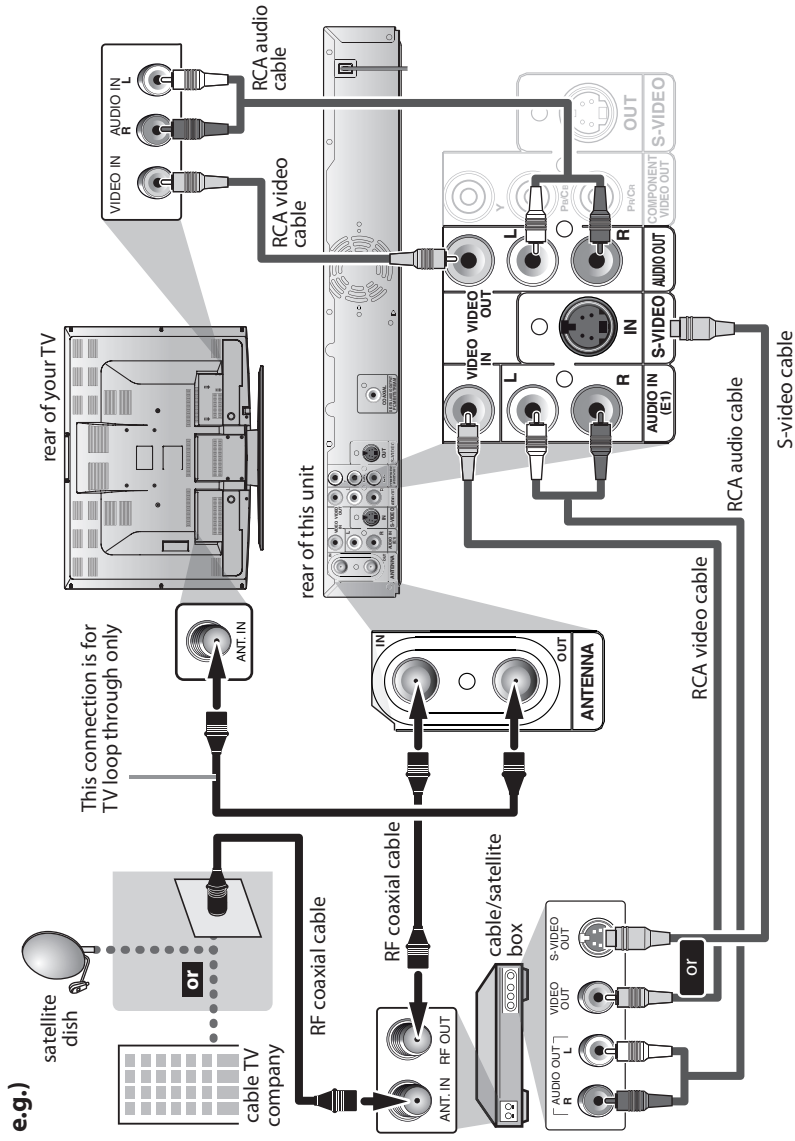

- 3) Plug in the power cords of the devices to the AC outlet.

Follow to the back side of this sheet.

2

Initial Setting

You need to follow these steps when you turn on this unit for the first time.

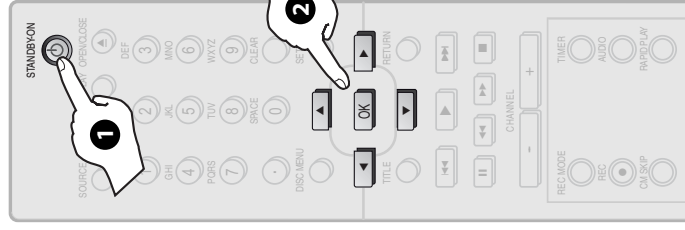

Press [STANDBY-ON ○].

Turn the TV on. Select the input to which the unit is connected.

Use [▲ / ▼] to select your desired language, then press [OK] to set language.

Use [▲ / ▼] to select the type of broadcasting signal, then press [OK].

The unit will start getting channels available in your area.

Press [OK] to activate "Clock Setting".

Use [◀ / ▶] to select an item to set, and use [▲ / ▼] to select the contents to suit your preference, then press [OK].

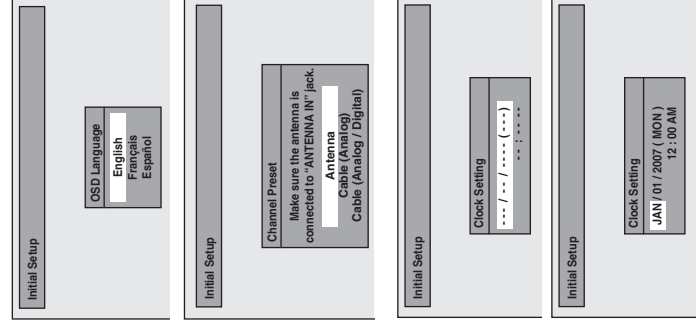

3

DVD Recording

3-1 Basic Recording

- Press [OPEN/CLOSE ▲] to open the disc tray and insert your disc with its label facing up.
* Make sure the disc is compatible with this unit. (Refer to page 31 in the owner's manual for the list of compatible discs.)
- Press [REC MODE] to select a recording mode.

Recording mode	Recording time	Video/sound quality
8cm Disc	172cm Disc	Good ↑ ↓ Poor
HQ (1HR)	60 min	
SP (2HR)	120 min	
SPP (2.5HR)	150 min	
LP (3HR)	180 min	
EP (4HR)	240 min	
SLP (6HR)	360 min	

- Press [DTV/TV] to select analog TV or digital TV, then use [CHANNEL + / -] or [the Number buttons] to select a desired channel to record.

- Press [REC ●] to start recording.

- Press [STOP ■] to stop recording.

To set one-touch timer recording (OTR)...

This is a simple way to set the recording time in blocks of 30 minutes. Press [REC ●] repeatedly until the desired recording time (30 minutes to 6 hours) appears on the TV screen. One-touch timer recording will start.
• To cancel one-touch timer recording within the specified time, press [STOP ■].

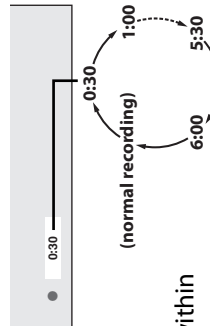

3-2

Timer Recording

You can program the unit to record up to 12 programs within a month in advance. Daily or weekly program recordings are also available.

Before recording, make sure

- Set the clock before setting a timer programming.
- Insert a recordable disc with enough recordable space.

- Press [TIMER].
- Use [▲ / ▼] to select "New Program", then press [OK].

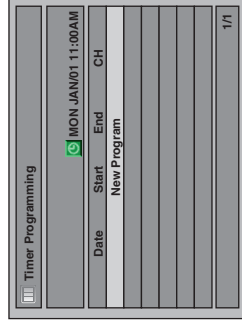

- Set a timer programming.
- Press [OK].

- Press [STANDBY-ON ○] to set a timer programming.

TIMER REC indicator will light up on the front panel.

Set the date.

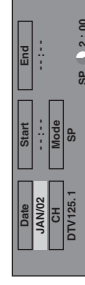

Set start and end time.

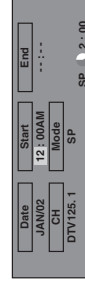

Select a desired input mode and channel to record. (* e.g.) digital mode

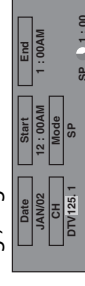

Select a recording mode.

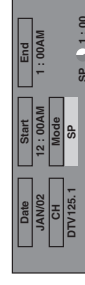

(* Refer to "How to select a channel number for the timer recording" on page 37 in the owner's manual for more details.

4

Playback

- Open the disc tray.
- Insert a disc.
- Start playing back.
- Stop playing back.

